

FAST BREAK SOCCER



score more goals - win more games

an essential guide for all soccer coaches

Dedicated to FIFA World Cup 2010

written by best selling soccer author Tom Sauder

foreword by David Mantel, Athletics Director

Acknowledgements

This book would not have been possible without the inspiration derived from coaching the Redeemer University College's (Ancaster, Canada) Mens Varsity soccer team. The necessity to find a way to score more goals in order to win more games led to a completely new and different approach to coaching the game. One of the innovations was to develop a new style of play supported by a new practice concept.

I would like to thank the Redeemer University College's Athletics Director, David Mantel, for his support with the development, testing, and refining of these drills and practices. I thank the 2008 varsity team and players for buying into this new style and proving on the field that this method works. They scored more goals and won more games.

The underlying principles behind the drills and practices have been found by studying professional soccer teams from around the globe, their coaches and their playing styles. That research confirmed that fast transition play with minimum touches on the ball is the modern way of soccer. My gratitude belongs to the innovative professional coaches who are not afraid to publicly share their approach to the game and the methods they use.

From World Cup 2006 through Euro 2008 Fast Break Soccer is becoming THE style of soccer. A recent news report confirmed that we called it right and are ahead of the competition:

"A counter-attacking World Cup? Fast-break soccer could be all the rage in South Africa....What will it be next year in South Africa? If current trends are any indication, the 2010 World Cup could be all about the counter-attack, and soccer played at a breakneck pace. "

CBC, December 2009

I thank my wife Kelly for her unwavering support during over 20 years of coaching the beautiful game, writing practice books and working on projects.

This book is dedicated to my mother Helga, who passed away far too soon and could not see the final product. I also dedicate this book to our granddaughter Kyra, who has become the bright inspiration in our lives and one day will be a soccer star.

Tom Sauder

Hamilton, Canada

Table of Contents

| | |
|---|-----------|
| Foreword | vi |
| Introduction | vii |
| Fast Break Soccer Practice # 1 | 1 |
| Warm Up # 1: dribbling & passing | 2 |
| Transition Play # 1: 4 v 4 with 3 groups | 3 |
| Soccer Speed # 1: pass, reaction sprint & 1v1 | 4 |
| Goal Scoring # 1: dribble & shoot - cross & head | 5 |
| Game Tactics # 1: 4 v 4 flank attack | 6 |
| Fast Break Soccer Practice # 2 | 7 |
| Warm Up # 2: passing & leg strengthening | 8 |
| Transition Play # 2: 2 teams of 6 in a 6 v 4 | 9 |
| Soccer Speed # 2: change of direction reaction sprints | 10 |
| Goal Scoring # 2: pass - overlap -2 v 1 - cross or finish | 11 |
| Game Tactics # 2: 7+1 v 7 | 12 |
| Fast Break Soccer Practice # 3 | 13 |
| Warm Up # 3: pass & dribble | 14 |
| Transition Play # 3: 4 v 2 in a 4 v 4 | 15 |
| Soccer Speed # 3: timing & reaction sprints | 16 |
| Goal Scoring # 3: header - turn - shoot | 17 |
| Game Tactics # 3: 6 v 6 marking & transition | 18 |
| Fast Break Soccer Practice # 4 | 19 |
| Warm Up # 4: circuit - passing & heading | 20 |
| Transition Play # 4: 2 v 2 in a 4 v 4 | 21 |
| Soccer Speed # 4: sprint & speed dribble | 22 |
| Goal Scoring # 4: 3 v 1 with crossing | 23 |
| Game Tactics # 5: 8 v 8 switching play | 24 |
| Fast Break Soccer Practice # 5 | 25 |
| Warm Up # 5: reaction run & 5 v 2 passing | 26 |
| Transition Play # 5: 7 v 7 on 5 goals | 27 |
| Soccer Speed # 5: short sprints after flexstarts | 28 |
| Goal Scoring # 5: dribble - shoot - 1 v 1 | 29 |
| Game Tactics # 5: 4 v 4 on 4 goals | 30 |

Table of Contents

| | |
|--|-----------|
| Fast Break Soccer Practice # 6 | 31 |
| Warm Up # 6: agility jog & anticipation passing | 32 |
| Transition Play # 6: two 1 v 1 across two fields | 33 |
| Soccer Speed # 6: reaction sprints & speed dribble | 34 |
| Goal Scoring # 6: 3 one touch passes & 1 v 1 on goal | 35 |
| Game Tactics # 6: 4 + 4N v 4 flank attack | 36 |
| | |
| Fast Break Soccer Practice # 7 | 37 |
| Warm Up # 7: dribble, pass, 1 v 1 moves | 38 |
| Transition Play # 7: 3 v 3 with shot on goal | 39 |
| Soccer Speed # 7: high speed change of direction dribble | 40 |
| Goal Scoring # 7: crossing and finishing | 41 |
| Game Tactics # 7: 4 v 4 with shot after lay-off pass | 42 |
| | |
| Fast Break Soccer Practice # 8 | 43 |
| Warm Up # 8: reaction jog - pass & follow | 44 |
| Transition Play # 8: 5 v 5 pass interception | 45 |
| Soccer Speed # 8: give & go - turn - sprint | 46 |
| Goal Scoring # 8: pass - hurdle sprint - 1v1 - shoot | 47 |
| Game Tactics # 8: 4 v 4 on 4 goals | 48 |
| | |
| Fast Break Soccer Practice # 9 | 49 |
| Warm Up # 9: reaction dribble & headers | 50 |
| Transition Play # 9: 4 v 4 attacking both goals | 51 |
| Soccer Speed # 9: sprint - receive - turn - dribble | 52 |
| Goal Scoring # 9: crossing & 2 v 1 | 53 |
| Game Tactics # 9: 4 v 4 and 3 v 2 | 54 |
| | |
| Fast Break Soccer Practice # 10 | 55 |
| Warm Up # 10: pursuit dribble | 56 |
| Transition Play # 10: 1 v 1 on two goals | 57 |
| Soccer Speed # 10: sprint and 1 v 1 | 58 |
| Goal Scoring # 10: combination passing & shooting | 59 |
| Game Tactics # 10: combination play & flank attack | 60 |

Table of Contents

| | |
|---|-----------|
| Fast Break Soccer Practice # 11 | 61 |
| Warm Up # 11: reaction & sequence passing | 62 |
| Transition Play # 11: 8 v 8 with defenders breaking fast | 63 |
| Soccer Speed # 11: pass - sprint - overlap | 64 |
| Goal Scoring # 11: receive pass - turn - dribble - pass - shoot | 65 |
| Game Tactics # 11: 8 v 8 on two goals with flank attack | 66 |
| | |
| Fast Break Soccer Practice # 12 | 67 |
| Warm Up # 12: dribble & pass with change of direction | 68 |
| Transition Play # 12: 7 v 7 on movable goal | 69 |
| Soccer Speed # 12: receive - pass - turn - sprint - receive | 70 |
| Goal Scoring # 12: sprint to pass - turn - 1 v 1 - shoot | 71 |
| Game Tactics # 12: 7 v 7 flank attack | 72 |
| | |
| Fast Break Soccer Practice # 13 | 73 |
| Warm Up # 13: agility dribble, pass & sprint follow | 74 |
| Transition Play # 13: (3 + 3) v 3 | 75 |
| Soccer Speed # 13: give & go passing | 76 |
| Goal Scoring # 13: reaction sprint & 1 v 1 on goal | 77 |
| Game Tactics # 13: 5 v 4 flank attack | 78 |
| | |
| Fast Break Soccer Practice # 14 | 79 |
| Warm Up # 14: body fake dribble & follow target pass | 80 |
| Transition Play # 14: 2 v 2 in diamond | 81 |
| Soccer Speed # 14: give & go with short passes | 82 |
| Goal Scoring # 14: 2 v 1 - shoot & convert cross | 83 |
| Game Tactics # 14: 6 v 6 + 1 v 1 with shot | 84 |
| | |
| Fast Break Soccer Practice # 15 | 85 |
| Warm Up # 15: dribble + one touch pass back of high toss | 86 |
| Transition Play # 15: 6 v 4 pressing & counterattack | 87 |
| Soccer Speed # 15: overlap sprints | 88 |
| Goal Scoring # 15: reaction & control - 1 v 1 - shoot | 89 |
| Game Tactics # 15: 4 v 4 & 2 neutrals flank attack | 90 |

Table of Contents

| | |
|---|------------|
| Fast Break Soccer Practice # 16 | 91 |
| Warm Up # 16: take - over dribble | 92 |
| Transition Play # 16: 4 v 3 with target player | 93 |
| Soccer Speed # 16: sprint - pass back - turn -sprint | 94 |
| Goal Scoring # 16: 2 v 2 give & go with overlap | 95 |
| Game Tactics # 16: 7 v 7 with free cross | 96 |
| | |
| Fast Break Soccer Practice # 17 | 97 |
| Warm Up # 17: stop & go dribble; 1 v 1 moves | 98 |
| Transition Play # 17: two teams play through 6 goals | 99 |
| Soccer Speed # 17: 3 v 1 in grid | 100 |
| Goal Scoring # 17: change of direction dribble & shot | 101 |
| Game Tactics # 17: quick transition team attack | 102 |
| | |
| Fast Break Soccer Practice # 18 | 103 |
| Warm Up # 18: passing & "man on" pass back or turn | 104 |
| Transition Play # 18: dribble - cross - finish - react - repeat | 105 |
| Soccer Speed # 18: sprint dribble with turns | 106 |
| Goal Scoring # 18: pass - lay off - shoot | 107 |
| Game Tactics # 18: 3 v 2 with shot on goal | 108 |
| | |
| Fast Break Soccer Practice # 19 | 109 |
| Warm Up # 19: out - in passing & 3 v 2 on 5 goals | 110 |
| Transition Play # 19: 6 v 6 with counterattack | 111 |
| Soccer Speed # 19: defend two goals | 112 |
| Goal Scoring # 19: passing & reaction 2 v 1 on goal | 113 |
| Game Tactics # 19: 8 v 8 into four corners | 114 |
| | |
| Fast Break Soccer Practice # 20 | 115 |
| Warm Up # 20: head or catch | 116 |
| Transition Play # 20: passing through traffic | 117 |
| Soccer Speed # 20: backward jog - sprint - 1 v 1 | 118 |
| Goal Scoring # 20: wall pass - 1 v 1 - shot - cross - finish | 119 |
| Game Tactics # 20: 4 v 4 on either goal | 120 |

Foreword

I am a convert. For much of my coaching career I believed that a methodical possession game was what should be taught to players and that the beautiful game was only beautiful when played in this way. My teams would make several successive passes and be in no danger of turning over the ball to the other team. Perfection! Right? Wrong. We were also in no danger of scoring a goal at the end of most passing successions.

I have had the privilege of implementing the program that is laid out in this book and enjoying the benefits that came from it. Through my first hand experience, I was able to identify many of the reasons why I now endorse this program so heavily.

This is the most well thought out and complete training program that I have seen. Everything from the overall team philosophy to the sequence of each practice is designed to give your team the skills and abilities to perform at their highest level. It not only improves the skill level of players, but it engages them and holds their interest and focus. Building on the essential building blocks of fitness, technical skills, and tactical skills, this program brings players through a series of practices that ask them to develop their mental game and their approach to the game at the same time.

For those coaches needing to refine all areas of their team, this program does it meticulously, methodically, and efficiently.

Fast Break Soccer teaches the players how to analyze, think, react, perceive, move, and anticipate. For a player, there is no better system than one that allows them to make the decisions in the game and at game speed. My experience with this program is that it unlocks the creativity that many of these players have rather than placing limits on their actions.

Fast break soccer successfully changed my philosophy and convinced me of a better, more beautiful way to play soccer. It also happened to result in an increase in goals for, a decrease in goals against, and our first Championship team in 10 years of coaching.

I am indebted to Tom for his work in putting this all together. I congratulate you for purchasing this book - it may be the most important single resource you ever use.

Enjoy the benefits!

David Mantel

Redeemer University College
Ancaster, Canada

Introduction

The basic truth of soccer has not changed. The purpose of the game is to score goals and to prevent the opponent from scoring. What is constantly changing is the way teams are trying to meet these objectives. At **fastbreaksoccer.com** we have developed a playing concept and set of practices to help your team score more goals, allow less goals against and win more games.

Our underlying philosophy is a fast transition game based on the principle of balance. When a team is in balance, it is set defensively to win the ball back and offensively to have players and the ball moving into the critical areas for scoring. Therefore, if you want to score more goals, your team needs to attack the opponent's goal while they are "off balance", or in other words, out of position and defensive shape. That is accomplished by attacking as fast as possible upon gaining possession of the ball. When your team loses possession, it needs to transition into defensive balance and shape faster than the opponent is attacking. You need to put pressure on the ball as quickly as possible and as deep in the other team's half as possible. At the same time your players need to mark and cover opposing players.

This style of play requires fast actions and fast actions require quick thinking and decision making. Players need to decide what they will do with the ball before they receive it. This is based on having a vision of the field and all players. After receiving the ball, players need to quickly perceive if the play they decided on before they got the ball is still available. They then need to react to a new situation or to the situation they anticipated and execute the planned play or a new one. The execution of the play needs to be fast and we promote two touch soccer with quick passes when possible. We advocate 1v1 situations in the attacking third to beat one defender to get ready for a shot or to set up a team mate.

Our practices then are structured to support this style of play. Our warm ups focus on execution of fundamental soccer skills as a refresher with the necessary stretching. Next is a transition drill to reinforce the concept of fast break soccer. It is important to realize that each soccer drill involving two groups trains both attacking and defending at the same time. Having reinforced transition speed, your team will go through a fitness drill training both mental and physical soccer speed. This is followed by a goal scoring drill. All the transition and attacking plays are only useful if the chances are converted to goals. That is why we set aside goal scoring as the only separate technical skill in our practices. The practice closes with a tactical game exercise which brings everything together in a game situation. This is where you, the coach, have an opportunity to train your team in your system of play within the context of fast break soccer.

All stretches required can be seen at: <http://www.soccerpracticebooks.com/stretch.html>

We wish you progress and success in your upcoming season.

FAST BREAK SOCCER PRACTICE # 1

Warm Up (20 min)

A. Individual Circuit

1. Dribble ball across field.
 2. Dribble through cones.
 3. Pass to yourself through cones, run outside cones and receive ball while it is still moving.
 4. Dribble zig zag keeping the ball inside the cones.
- Do two trips around circuit

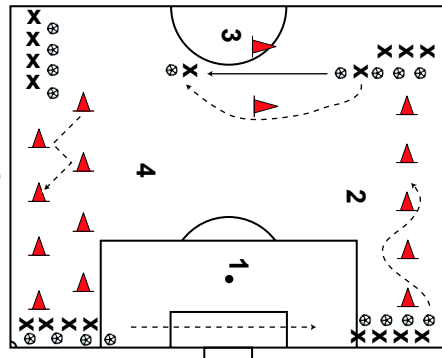

B. Runner's & Hamstring Stretches

C. Two Touch Passing

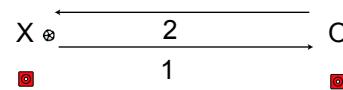

X and O pass to each other- two touch, first touch to receive and set up second touch pass. Go for 4 minutes.

D. Quad & Personal Stretches

Transition Play (30 min)

Field of play is an area twice the size of the penalty box.

A attacks goal 1 which B defends. If A scores, a save is made by GK, B wins ball, or ball goes out of bounds, B gets possession of ball and attacks goal 2.

Goal 2 will immediately be defended by team C coming off goal line.

Team A immediately drops to goal line 1 and waits to defend attack by C.

Attacking team always drops to goal line as quickly as possible.

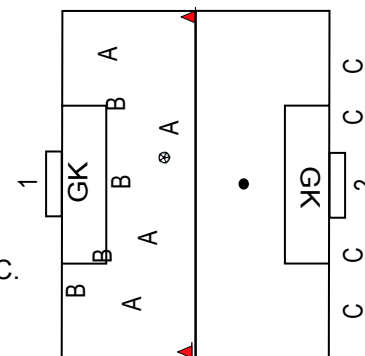

Soccer Speed (10 min)

1. X stands with legs apart and O, with ball, is 1m behind X. O passes ball through X's legs.
2. O runs around X after ball and goes for goal. As soon as X sees ball, X sprints to play 1v1 on goal against O. Switch roles.

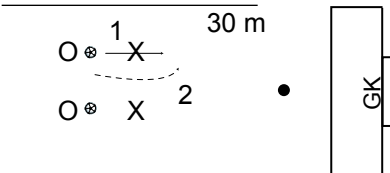

Goal Scoring (30 min)

1. Player X from group A dribbles ball to cone.
2. X passes ball in front of cone.
3. X sprints around cone to go for a first touch shot on goal.
4. X strikes ball aiming at far post.
5. X now sprints to head a cross.
6. O plays a well timed cross from opposite side.

Timing of run, shot by X and dribble and cross by O must be such that the drill runs smoothly without anyone ever waiting for a ball.

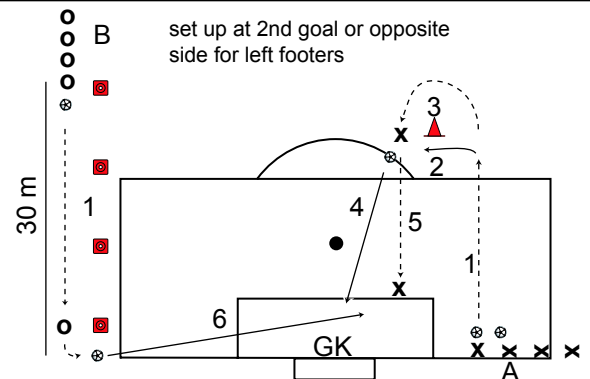

Game Tactics (30 min)

1. X play against O in a 40 by 35 grid.
2. X attacks goal and O defends.
3. X must pass ball to a player into zone A or B before they can score
4. O's cannot enter areas A or B.
5. Once X has possession in area A or B they can cross ball or play it back into grid.
6. If O's win ball, they fast break on opposite goal while X's transition back to defend.

Regular soccer rules except for off-side apply to restart game.

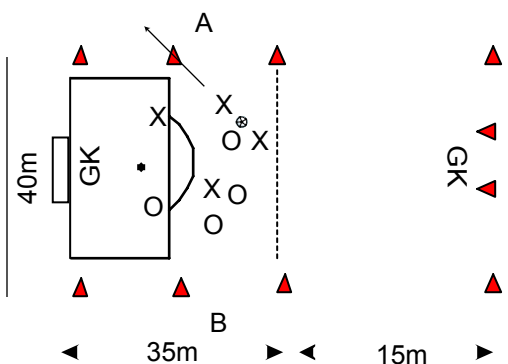

Players should be busy at all times. If drills keep players inactive, break team into smaller groups and run parallel drills.

FAST BREAK SOCCER WARM UP # 1

Dribbling & Passing

A. Individual Circuit

1. dribble ball across field.
 2. dribble through cones.
 3. pass to yourself through cones, run outside cones and receive ball while it is still moving.
 4. dribble zig zag keeping the ball inside the cones.
- Do two trips around circuit

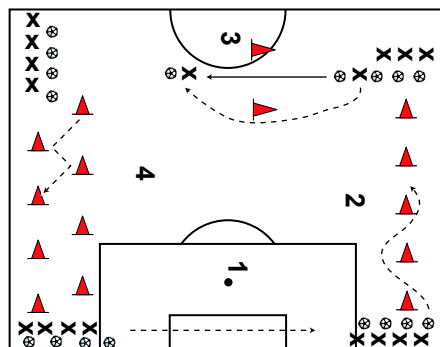

B. Runner's & Hamstring Stretches

C. Two Touch Passing

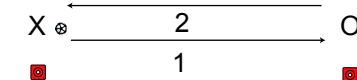

X and O pass to each other- two touch, first touch to receive and set up second touch pass. Go for 4 minutes.

D. Quad & Personal Stretches

Coaching Points

1. Circuits

station 1: Keep ball close to feet, emphasize control over speed, increase speed as control improves

station 2: Place as many cones as you can. Challenge players not to knock down cones.

station 3: Timing of the pass and run is critical. Players must pass, sprint around cone and arrive at other side of little goal at the same time as the ball - no waiting, no loss of control.

station 4: It is important to stay within cones. As players change direction, they can (don't have to) also switch from touching ball with outside (moving to right) to inside (moving to left) foot.

2. Two Touch Passing:

It is important to control the weight of the pass such that the receiver can control the ball with the first touch and follow through immediately with the second touch pass. The first touch has to be at an angle to the outside and away from the foot to set up the second touch. While waiting, players must jog on their toes - do not let them stand flat-footed. Passes that are too hard will force errors and loss of control from the receiver. Players need to determine how hard a pass their partner can handle comfortably and then serve at that pace (weight).

Favour accuracy and smooth, flowing execution over pace.

Game Application

This warm up is all about ball control - dribbling straight and varying directions, proper passing weight and receiving.

Players on your team need to understand their capability so that the team maintains control during the game. This sounds easier than it is.

Two touch soccer is very critical to any team's success. The first (receiving) touch needs to be away from the body and in the direction of the next intended play by the player for either a dribble or a pass.

It is important that players learn each other's abilities, preferences and moves. These drills are vital building blocks.

FAST BREAK SOCCER TRANSITION PLAY # 1

4 v 4 With 3 Groups

Field of play is an area twice the size of the penalty box.

A attacks goal 1 which B defends. If A scores, a save is made by GK, B wins ball, or ball goes out of bounds, B gets possession of ball and attacks goal 2.

Goal 2 will immediately be defended by team C coming off goal line.

Team A immediately drops to goal line 1 and waits to defend attack by C.

Attacking team always drops to goal line as quickly as possible.

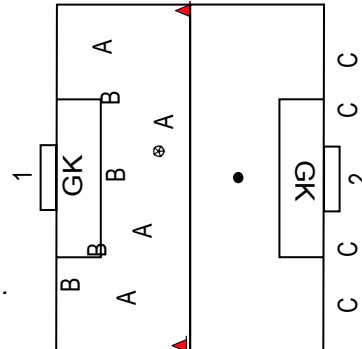

Coaching Points

1. It is critical that the team waiting on the goal line perceives change of possession in the other half and comes out to challenge the attacking team as quickly as possible.
2. All regular soccer rules apply: challenging player with ball, covering other players, closing passing lanes for defenders, two touch passing, give and gos, overlaps, crosses, finishing, for attackers.
3. To keep the game flowing, the attacking team has to get off the field as fast as possible once their play is over. They need to be watching the game on the field and get ready to come back off the line and defend.
4. Communication is very important so that all teams are organized all the time.
5. Create the groups of four based on how they play together in a game. For example, have four defenders on team A, four midfielders on team B and four attackers on team C. Then mix it up based on how your team transitions in a game. Team A could be 2 defenders, one midfielder, one forward; team B could be 2 defenders, 2 midfielders; team C could be one defender, one midfielder and 2 forwards.
6. Substitute extra players in freely.

It is recommended to plan out the compositions of each group and variations before practice.

Game Application

In fast break soccer, teams need to transition from defense to offense and from offense to defense very fast.

Closing down and pressuring the opponents quickly to gain possession and then transitioning to be in a goal scoring position as fast as possible is vital.

Perception of passing lanes by opponents and closing them down while maintaining team shape is important.

FAST BREAK SOCCER SPEED # 1

Pass, Reaction Sprint & 1 v 1

1. X stands with legs apart and O, with ball, is 1m behind X.
O passes ball through X's legs.
2. O runs around X after ball and goes for goal. As soon as X sees ball, X sprints to play 1v1 on goal against O. Switch roles.

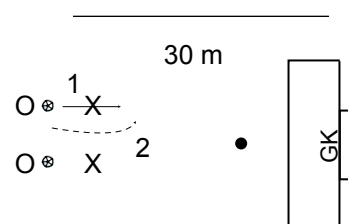

Coaching Points

1. The weight of the pass through the legs is critical. The ball should be played far enough to give O a head start on the 1v1, but close enough to avoid being in a simple sprint against X.
2. O needs to maintain the element of surprise and advantage in the play.

This drill is mostly for players in the X role to develop reaction speed.

Game Application

One of the key game skills is reaction speed. Player X has to react to new information (seeing ball) and then decide whether or not to sprint to the ball, or sprint goal side to defend against O.

FAST BREAK SOCCER GOAL SCORING # 1

Dribble & Shoot - Cross & Head

1. Player X from group A dribbles ball to cone.
At the same time O from group B dribbles down line for a cross.
2. X passes ball in front of cone and
3. sprints around cone to go for a
4. first touch shot on goal.
5. X now sprints to head a
6. cross coming from opposite side player O.

Timing of run, shot by X and dribble and cross by O must be such that the drill runs smoothly without anyone ever waiting for a ball.

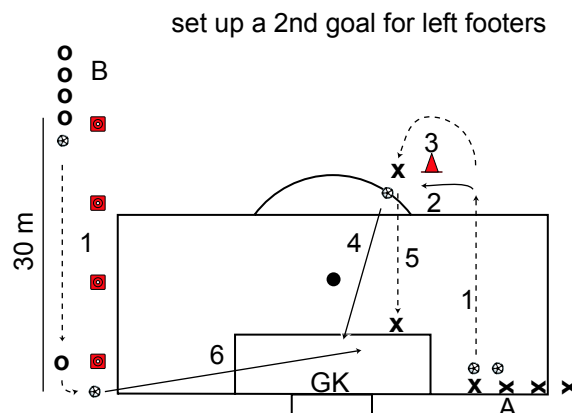

Coaching Points

1. X's dribbling to cone must keep ball close to foot and play a pass straight across in front of cone or diagonally towards goal to be able to run into the shot. The turn around the cone must be fast, crisp and end up with the body positioned at the proper angle (square to target) for a one time shot.
2. O's need to time their dribble down the side such that the cross is made after the shot by X. O cannot stop the dribble, it must be continuous and it is better to delay the start.
3. After the shot, X needs to be aware of the dribble and cross by O and time the sprint for the header. Again, it is better for X to delay the sprint to the header than to wait on the cross. This makes for more powerful headers.
4. Cross should be to far post just outside the 5m box, i.e. out of reach of goalkeeper and should be from as close to goal line as possible. O must make a last touch of ball angled towards target area/player prior to cross.
5. Goalkeeper plays to save shot and recovers quickly to intercept cross or be in the right position to save header.
6. Alternate roles of X's and O's if time permits.

If you are not sure which positions your players will play, this drill will show goal scorers and wingers.

Game Application

Playing wide for crosses is one of the standard goal scoring set ups in soccer. The accuracy of crosses into the back of defenders and away from the goalkeeper is key. The timing of the run for the header to speed past defenders is what makes the difference between scoring or wasting a chance.

Having a shot followed by a header is excellent training to teach players to go for or react to second chances.

FAST BREAK SOCCER GAME TACTICS # 1

4 v 4 Flank Attack

1. X play against O in a 40 x 35 grid.
2. X attacks goal and O defends.
3. X must pass ball to a player into zone A or B before they can score
4. O's cannot enter areas A or B.
5. Once X has possession in area A or B they can cross ball or play it back into grid.
6. If O's win ball, they fast break on opposite goal while X's transition back to defend.

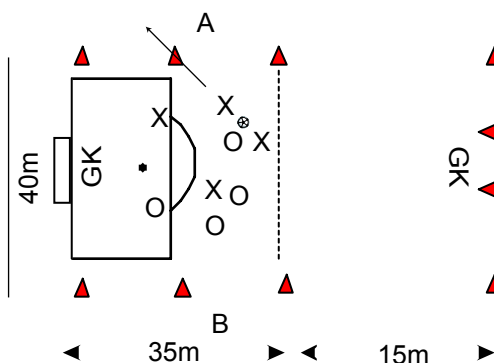

Regular soccer rules, except for off-side, apply to restart the game.

Coaching Points

1. See the opportunity to play ball wide into areas A or B, don't be afraid to play a long ball across to switch sides.
2. Players must make the runs into areas A and B and communicate to players with ball.
3. Use attacking midfielders and forwards to attack and defenders to defend.
4. Set up two drills if you have enough players, otherwise rotate them in on the fly.
5. Expand the drill to 6v6 or 8v8 and make field larger if you do so.
6. If you expand to 6v6 make sure to play the right combination of players together to match your system of play. For example, if you play 4-4-2 with overlapping defenders, you may want to attack with the outside defenders, the outside midfielders and the strikers and defend with 4 defenders and two inside midfielders.

If the drill runs well quickly, you can allow defenders into areas A and B .

Plan your combinations before practice.

Game Application

A lot of goals are scored from crosses and playing different players wide adds elements of surprise to the attack.

Have strikers go wide to cross into on-rushing central midfielders or outside midfielders who have cut inside to lose their defenders.

FAST BREAK SOCCER PRACTICE # 2

Warm Up (20 min)

A. 4 v 2 Passing

group of 4 keeps possession and scores one point for a completed pass and two points for a pass completed between defenders.

Rotate two defenders after 3 minutes

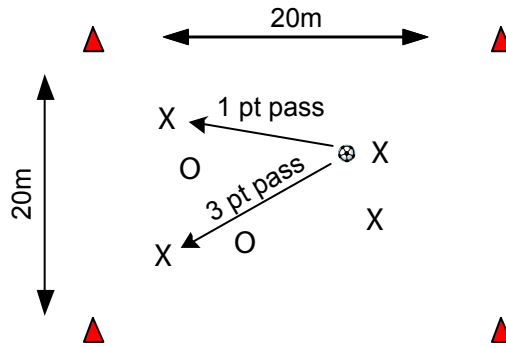

B. Runner's & Hamstring Stretches

C. Leg Strengthening

Each player with a ball. Stand beside ball and hop over it sideways. Both feet must be together and clear ball completely. Do three sets of 20 hops.

D. Quad and Personal Stretches

Transition Play (30 min)

Two teams of 6 play on 1/2 field divided by a center line. Two channels (lanes) are marked along each side of the field. X plays right to left attacking goal 1, O plays left to right on goal 2. Each team has two players who stay in the attacking lanes as shown. Players from the other team cannot enter these lanes. In the diagram shown, O defends goal 1, X plays 6 V 4 on goal 1. After X scores or O wins ball, teams break into the other half. O's now attack goal 2. X1, X2, X4 and X5 transition (sprint) across center to defend goal 2. O's transition (sprint) to play 6V4 against X. The two remaining X3 and X6 go into wide lanes and wait for next transition

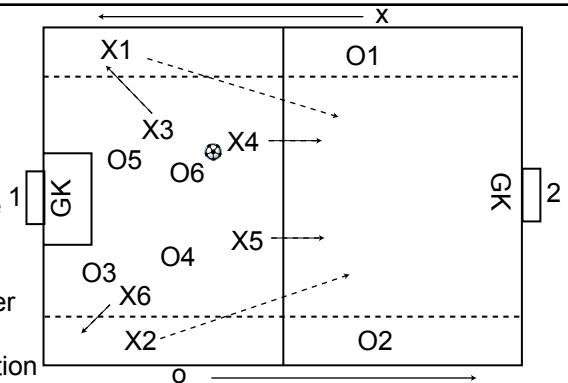

Soccer Speed (10 min)

Two players are on opposite sides of an imaginary line between two cones, 10 m apart. X sprints between cones changing direction often, trying to lose O. O reacts to X moves. Every time X "fakes out" O and gets to a cone first, X gets a point. Reverse roles every 60 seconds, 4 turns each.

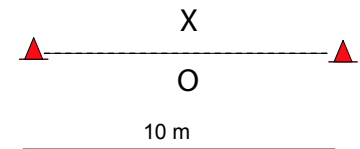

Goal Scoring (30 min)

- X passes into space to O, who runs and receives ball
- After pass X overlaps O.
- O controls the ball with their first touch and passes back to X with second touch. X now faces defender D who is positioned between two cones, which are 10 m apart. X now has two choices:
 - X beats defender inside far cone, dribbles to goal line and
 - crosses to O who has run into position to receive cross and finish
- or
 - If X cannot beat D inside cone, X passes back to O who
 - dribbles through cones past D and finishes on goal.

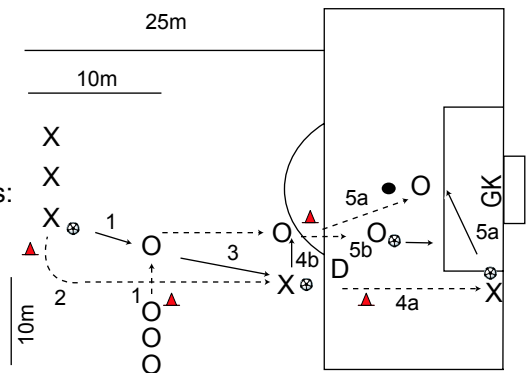

Game Tactics (30 min)

7+1 v 7 on 3/4 field

A 1 starts play with a pass to attackers (A). Attackers (A) must dribble through small goal to score. They can not be challenged after they pass through small goal. If defenders (D) win ball, they play it out quickly to A1 who waits in neutral zone and restarts attack.

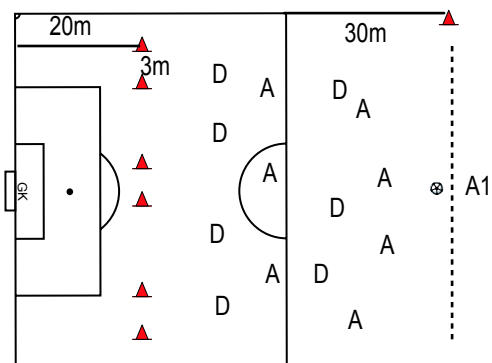

Players should be busy at all times. If drills keep players inactive, break team into smaller groups and run parallel drills.

FAST BREAK SOCCER WARM UP # 2

Passing & Leg Strengthening

A. 4 v 2 Passing

Group of 4 keeps possession and scores one point for a completed pass and two points for a pass completed between defenders.

Rotate two defenders after 3 minutes

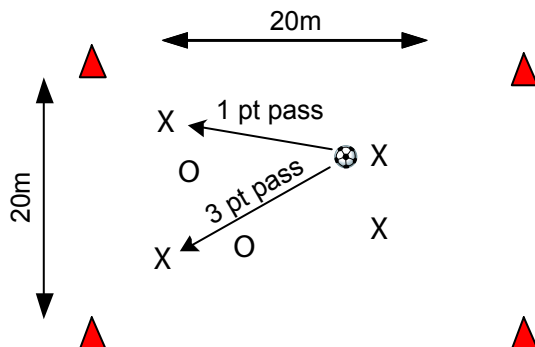

B. Runner's & Hamstring Stretches

C. Leg Strengthening

Each player with a ball. Stand beside ball and hop over it sideways. Both feet must be together and clear ball completely. Do three sets of 20 hops.

D. Quad and Personal Stretches

Coaching Points

Passing Drill:

1. Emphasize movement by the attackers to open up space and therefore open up lanes between defenders.
2. Try to set up three passing options, one support, one wide and one vertical (splitting defense)
3. Maximum two touches on the ball to force quick decision making and movement.
4. All attackers must be moving at all times.
5. Get players to pass to feet as well as into space anticipating runs.
6. Defenders need to work close together - first defender (closest to ball) must challenge, second defender must cover close as well as cut off passing lane.
7. Defenders need to anticipate passes and have vision to perceive attacking runs.
8. The attacking group needs to consist of players that combine in your team formation, i.e. 3 midfielders + striker, or 2 midfielders + 2 strikers, or 1 defender + 2 midfielders + 1 striker - plan this out ahead of practice.

Jumping Drill:

1. Make sure feet stay together and the hop is over top of ball, not in front or behind.
2. Ball cannot be touched, must be a clear jump.

Game Application

The passing drill mirrors what you want to see in an attacking style of soccer. Quick two touch passing and off the ball support movement is the most effective way of breaking down defenses. The pass splitting the defenders, particularly in the attacking third, is practiced by pro teams everywhere. Deciding whether to play a pass to the feet or into space depends on the position of defenders, space available, and knowledge of the running patterns of team mates. Knowing this in a game is vital information. Use this drill to get players to learn about each other and to communicate their preferences.

Defenders may be in a situation of being outnumbered. They need to learn and communicate who the first defender is, the speed at which to close down opponent and when (if at all) to tackle. The role of the first defender is to delay the attacking movements and challenge for ball only if the attacker loses tight control. The second defender needs to cover and be ready to challenge if the first defender gets beat. Second defender must also be aware of attackers passing options, be ready to close down passing lanes quickly and intercept passes.

FAST BREAK SOCCER TRANSITION PLAY # 2

2 Teams of 6 in a 6 v 4

Two teams of 6 play on 1/2 field divided by a center line. Two channels (lanes) are marked along each side of the field. X plays right to left attacking goal 1, O plays left to right on goal 2. Each team has two players who stay in the attacking lanes as shown, players from the other team cannot enter these lanes. In the diagram shown, O defends goal 1, X plays 6 V 4 on goal 1. After X scores or O wins ball, teams break into the other half. O's now attack goal 2. X1, X2, X4 and X5 transition (sprint) across center to defend goal 2. O's transition (sprint) to play 6v4 against X. The two remaining X3 and X6 go into wide lanes and wait for next transition

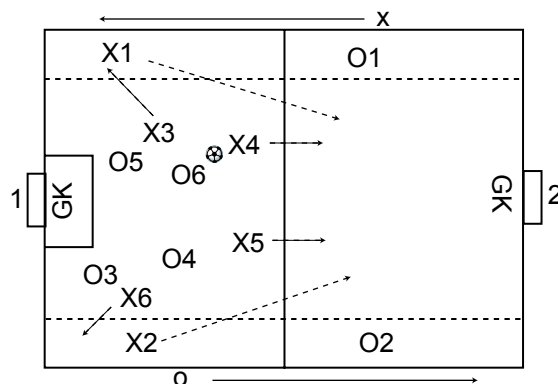

Coaching Points

1. When attacking, spread the field to include the flank players - this will spread the defense.
2. Drill can progress by allowing defenders into outside lanes and/or allowing attacking lane players to enter field of play after they receive ball (i.e. dribble in).
3. Attackers need to play two touch as much as possible.
4. Attackers can set up crosses or 1v1 situations just outside or in the penalty box to get a shot.
5. When transitioning to the other half, players must sprint into positions, ball must move quickly.
6. Recommended set up is to have 4 midfielders and 2 strikers play against 4 defenders and 2 midfielders.
7. If you have extra players, substitute them in "on the fly".
8. Players need to decide who stays back when transitioning into other half - typically, the players furthest back stay behind.
8. This drill is suited for a 4-4-2 system of play. If you play a different system, modify the number of players to closer match your formation (i.e. if you play 3-5-2 set up drill as 7 v 7).
9. Encourage the occasional long pass across field to change point of attack and unbalance the defense.

Game Application

This drill teaches playing wide to stretch the defense and then to work the ball back in the middle for a shot on goal. Alternatively the attack can start through the middle and switch wide. These are tactical building blocks of modern day soccer. The transition play at high speed gets your team to get behind the ball as quickly as possible to put pressure on the opponent. In the reverse, if you break out of your defensive zone fast it will keep your opponent off balance and increase your odds to set up quality scoring chances.

Transition speed is of the essence and good and clear communication is an asset.

FAST BREAK SOCCER SPEED # 2

Change of Direction Reaction Sprints

Two players are on opposite sides of an imaginary line between two cones, 10 m apart. X sprints between cones changing direction often, trying to lose O. O reacts to X moves. Every time X "fakes out" O and gets to a cone first, X gets a point. Reverse roles every 60 seconds, 4 turns each.

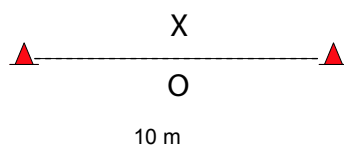

Coaching Points

1. Get players to change direction often.
2. Players need to develop and use quick body fakes (head, shoulder leaning, etc.) to get defender moving one way while quickly turning and sprinting in the opposite direction.
3. Develops reaction speed.
4. Coach can adjust the number of sprints per player based on fitness development need.

Game Application

Players are constantly marked and losing defenders is important. The common terminology for attacking players is to "check in" and "check out". This means to take a step or two in one direction drawing the defender with them and then suddenly moving in the opposite direction to increase space to defender. Player now has space to receive a pass. The ability to have head or body fakes to get a defender moving one way while player moves opposite way is valuable. The same eventually applies when dribbling 1v1.

FAST BREAK SOCCER GOAL SCORING # 2

Pass - Overlap - 2 v 1 - Cross or Finish

1. X passes into space to O, who runs and receives ball
2. After pass X overlaps O.
3. O controls the ball with first touch and passes back to X with second touch. X now faces defender D who is positioned between two cones, which are 10 m apart. X now has two choices:
- 4a. X beats defender inside far cone, dribbles to goal line and
- 5a. crosses to O who has run into position to receive cross and finish or
- 4b. If X cannot beat D inside cone, X passes back to O who
- 5b. dribbles through cones past D and finishes on goal.

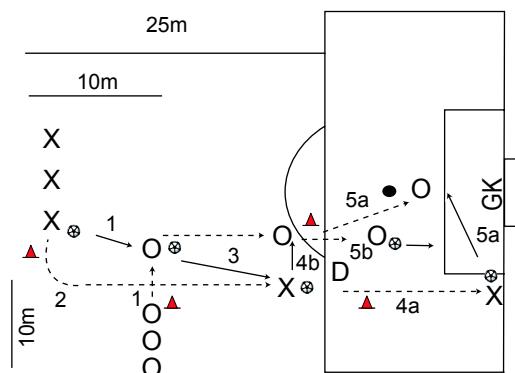

Coaching Points

1. This is a very complex combination drill requiring exact timing of runs and passes, therefore emphasize correct movements over speed initially until players are comfortable with sequences. Then pick up speed.
2. O needs to let X know that he/she is available for pass if X struggles to beat defender D.
3. This is the critical moment of this drill. Player X is approaching defender D and tries to beat D 1v1 and while focussing on the 1v1, receives information from a team mate. X needs to make a decision while moving and controlling the ball which is extremely difficult to do. Be prepared for X to be "between two minds" and cause the movement/drill to break down or stop. Keep repeating until X's get it right.
4. X's and O's should be your midfielders and strikers. Once they are comfortable with drill, rotate their jobs.
5. D are your defenders and you can rotate them into drill after every two tries.

Key Points:

It is absolutely critical that the attacker approaches goal being defended by D from the center. That leaves both options in play. A fake left can set up a successful 1v1 on the right and a fake/move to the right can open space for the pass to O and for O to dribble through.

O needs to delay the run to the little goal to leave space to run onto a pass from X. O also needs to delay the run to finish the cross from X for option (a)..

Game Application

This drill combines all necessary elements to break down a defense with combination plays. Passes into space are effective. Quick, two touch turns, leading to a pass are common. The give and go with overlap can be seen frequently at high levels of soccer. The key to this drill are the decisions that have to be made, especially the one by X taking on the defender 1v1. These are typical game situations and your team needs to make those decisions quickly and with confidence to keep the play flowing. This will keep defenders off balance. If your flow slows or breaks down, the opportunity for a quick and decisive strike on goal will be lost and your team needs to regroup. Fast break or fast attacking soccer needs plays like this to be executed well.

FAST BREAK SOCCER GAME TACTICS # 2

7 + 1 v 7

7+1 v 7 on 3/4 field

A 1 starts play with a pass to attackers (A).
Attackers (A) must dribble through small goal to score.
They can not be challenged after they pass through small goal.
If defenders (D) win ball, they play it out quickly to A1 who waits in neutral zone and restarts attack.

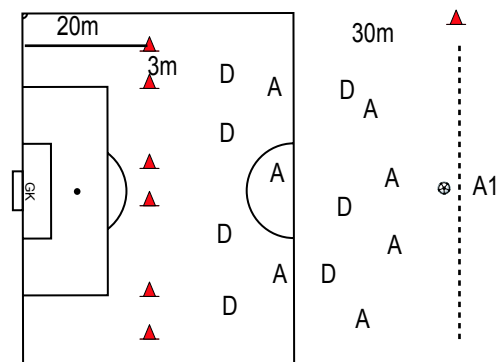

Coaching Points

1. Attackers need to be in constant movement and give A1 several options to start play.
2. Attackers can draw the defenders to one side of field and then switch play across to open side.
3. Near small goals, ask attackers to set up 2v1 for a quick pass and dribble through.
4. Only attacker dribbling through goal can finish.
5. Defenders need to transition the ball back to target player A1 with as few touches as possible after winning ball.
6. Anticipation, perception and decision making are key mental skills being trained.
7. Attackers need to create passing options for each other, such as give & go, overlap runs, square support passes, diagonal runs & passes.
8. Defenders are not allowed to stay in any of the three goals. They must challenge and mark attackers.

Game Application

The key to success in a game is how quickly your team can attack and keep opponents unbalanced. Attacking one side of the field and switching point of attack suddenly requires an almost "blind" understanding between your players. Quick transition play from defense to attack is effective. Put your groups together for this drill to be consistent with your system of play.

FAST BREAK SOCCER PRACTICE # 3

Warm Up (20 min)

A. Pass & Dribble

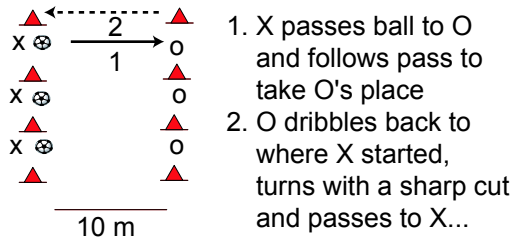

B. Runner's & Hamstring Stretches

C. Sharp Turn Dribble

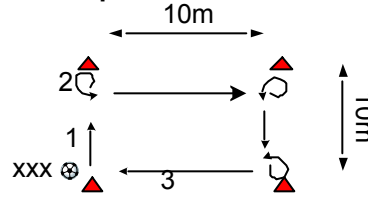

1. Dribble to cone.
2. Twist 3/4 turn in front of cone and dribble to next cone. Repeat twists
3. Pass to next player

D. Quad and Personal Stretches

Transition Play (30 min)

4 v. 4 on two full size goals.
Two defenders (B) must be on goal line before other players (B) can tackle attackers (A), who must have all players in opposing half before they can score.
After change of possession to defending team (B) or goal, A's must get two players on goal line before other two can tackle the other team (B).
Meanwhile, new attacking team (B) must have all 4 players in other half before they can score.

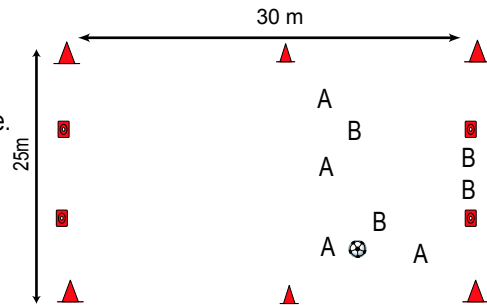

Soccer Speed (10 min)

1. X walks toward the marked line (any line on field) and times walk such that the right foot steps on the line. X then pushes off the right foot for a 10 m sprint.
2. X jogs to line to hit line with right foot, then pushes off and sprints 10 m. Alternate hitting the line with right/left foot.

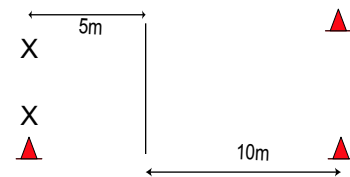

Goal Scoring (20 min)

1. Coach (C) times his throw to the run of X.
2. X goes for header on goal.
3. C now passes ball to the right of X who has turned after the header.
4. X receives ball and with first touch towards net sets up a shot.

X goes to the end of line and next X starts.

Use cones to make goals for additional groups and rotate players through goalkeeper position as necessary.

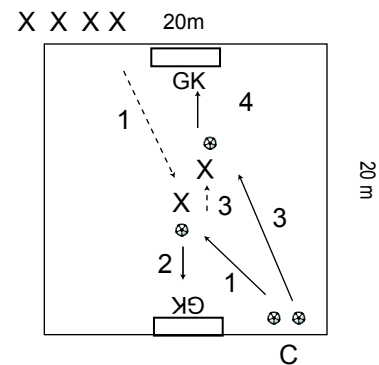

Game Tactics (30 min)

1. Play across 1/2 field 6 v 6 on full size goals.
2. Team in possession (X in diagram) plays to score.
3. Defending team (O) needs to mark each player of X, but must also have one player provide cover in case the challenging defender gets beat. In the example shown, O1 covers, but is also ready to challenge should the ball be played to X1.
4. Once O wins ball (successful challenge or restart play), O breaks fast and transitions hard to attack X's goal. X now need to immediately switch to defense, challenge O with ball, provide cover and mark everyone else.

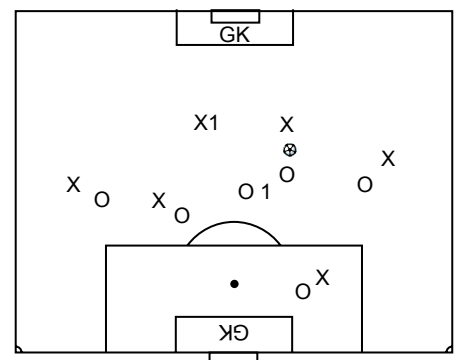

Players should be busy at all times. If drills keep players inactive, break team into smaller groups and run parallel drills.

FAST BREAK SOCCER WARM UP # 3

Pass & Dribble

A. Pass & Dribble

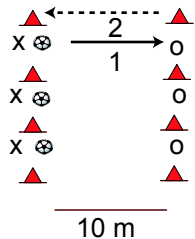

1. X passes ball to O and follows pass to take O's place
2. O dribbles back to where X started, turns with a sharp cut and passes to X...

C. Sharp Turn Dribble

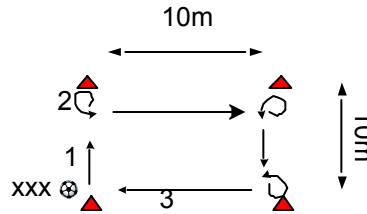

1. Dribble to cone.
2. Twist 3/4 turn in front of cone and dribble to next cone. Repeat twists.
3. Pass to next player

B. Runner's & Hamstring Stretches

D. Quad and Personal Stretches

Coaching Points

A. Pass & Dribble

1. Passes must be two touch - do not hit dead balls.
2. Receive ball first touch forward in direction of dribble.
3. Time dribble to cut back ball exactly on the line, keeping ball rolling in direction of pass. Then player pivots quickly and passes on second touch after turn.
4. X and O should time their runs, dribbles and weight of passes so that neither has to wait, both are in constant motion.

C. Sharp Turn Dribble

1. Dribble ball close to foot.
2. Execute tight turns at cones.
3. Focus on precise passing after last turn so that receiver can control ball easily.
4. Receiver control with first touch in direction of dribble.
5. Add a second ball to each grid or reduce numbers of players per grid if players wait too much.

Game Application

Short, properly weighted two touch passing is a fundamental building block of team play. Dribbling and cutting back 180 degrees is often referred to as a "retreat" move. A player dribbles and runs into opposing defenders with nowhere to go. Execute a tight turn to get your back to defenders and open up play behind you for a pass to a supporting team mate or a dribble into space.

FAST BREAK SOCCER TRANSITION PLAY # 3

4 v 2 in a 4 v 4

4 v. 4 on two full size goals.

Two defenders (B) must be on goal line before other players (B) can tackle attackers (A), who must have all players in opposing half before they can score.

After change of possession to defending team (B) or goal, A's must get two players on goal line before other two can tackle the other team (B).

Meanwhile, new attacking team (B) must have all 4 players in other half before they can score.

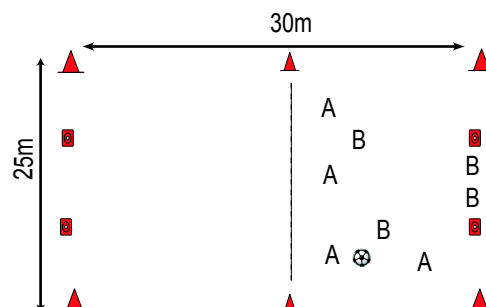

Coaching Points

1. Attacking team always plays 4v2.
2. Players must communicate (before drill starts or during drill) which two players will defend the goal line. They could decide that the players closest to the goal line must defend the line.
3. After change of possession (goal, out of bounds, successful tackle), both teams must transition into the other half as fast as possible - look for sprinting, not jogging or walking.
4. The team that was defending and now is breaking to attack must get all players across half as fast as possible, with as few team touches as possible. Watch for the players on goal line to be delayed due to "ball watching".
5. It is critical that two defenders get back on the goal line - they cannot challenge at all.
6. Match your teams according to your game formation - in a 4-4-2, you might have two midfielders and two strikers against two defenders and two midfielders. Or mix it up, four midfielders v four defenders, etc.

This drill should be moving at a high pace. Communication, reaction and sprinting speeds are all developed.

Game Application

This drill requires fast transition to attack and fast transition to defense. Training quick transition from attacking to defending actually allows your team to attack with more players than most teams. This is because your players know that if they lose possession, they will transition back fast enough to gain defensive shape back.

Having the closest players to the goal in this drill come back to the goal line represents recovery runs by your players during a game.

By transitioning to attack fast and with numbers after gaining possession, particularly in the opposing half, you will catch the opponent off-balance and create more scoring chances.

This is one of the few drills that encompasses all essential elements of modern soccer.

FAST BREAK SOCCER SPEED # 3

Timing & Reaction Sprints

1. X walks toward the marked line (any line on field) and times walk such that the right foot steps on the line. X then pushes off the right foot for a 10 m sprint.

2. X jogs to line to hit line with right foot, then pushes off and sprints 10 m.

Alternate hitting the line with right/left foot.

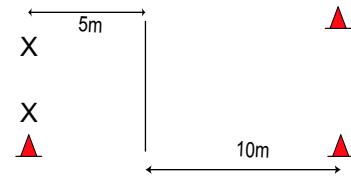

Coaching Points

1. Concentration to hit the line every time must be stressed.
2. Be picky - let them know when they miss the line.

Game Application

Walking or jogging and then quickly accelerating is one technique to get away from marking opponents and open up space for yourself. Effective at throw-ins, short passes or beating an off-side trap.

FAST BREAK SOCCER GOAL SCORING # 3

Header - Turn - Shot

1. Coach (C) times his throw to the run of X.
2. X goes for a header on goal.
3. C now passes ball to the right of X who has turned after the header.
4. X receives ball and with first touch towards net sets up a shot.

X goes to the end of line and next X starts.

Use cones to make goals for additional groups and rotate players through goalkeeper position as necessary.

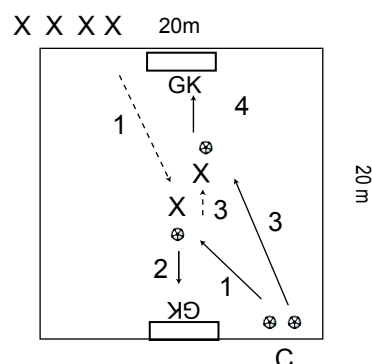

Coaching Points

1. Player needs to execute header with power, throw must be at appropriate height.
2. Coach must concentrate on timing of player run.
3. After header, players cannot stop and watch result of header, they must immediately change direction (get off ground after diving header or fall) and sprint for the shot.
4. Challenge players to finish with two goals.
5. Use your regular goalies for a group consisting of your strikers.

Game Application

Players often get opportunities to go for a second chance (rebound, ball off post, misdirected clearance, etc.) but often fail to take it. This is because they do not recover from their previous action quick enough to be in a position to take advantage of a second chance. This drill practices quick recovery and reaction to a second chance.

Players also change direction frequently - a key transition play focus. They may have taken a header and now need to turn and sprint after a loose ball.

FAST BREAK SOCCER GAME TACTICS # 3

6 v 6 Marking & Transition

1. Play across 1/2 field 6 v 6 on full size goals.
2. Team in possession (X in diagram) plays to score.
3. Defending team (O) needs to mark each player of X, but must also have one player provide cover in case the challenging defender gets beat. In the example shown, O1 covers, but is also ready to challenge should the ball be played to X1.
4. Once O wins ball (successful challenge or restart play), O breaks fast and transitions hard to attack X's goal. X now need to immediately switch to defense, challenge O with ball, provide cover and mark everyone else.

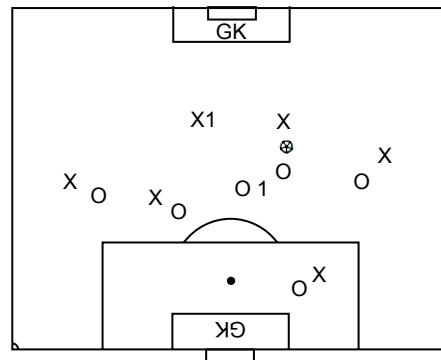

Coaching Points

1. Attacking team must use quick moves and runs off the ball to lose marking defenders.
2. Defenders must have one player challenging attacker with ball and one player in a covering role. This will leave one of the attackers somewhat unmarked. This should be the attacker in the least dangerous position. Another defender needs to keep an eye on that open player while marking their own attacker.
3. Defending team needs to be in constant communication.
4. Make sure nobody on defending team marks space. This is not a zonal defense exercise.
5. On transition, get previously defending team to break fast, forcing attackers to transition fast to defense.
6. Defending team must mark attackers goal side as quickly as possible.

Game Application

Marking and covering (or keeping an eye on) each of the opposing players when they have the ball is the best way to regain possession and to start your own attack.

Reacting quickly to change of possession is essential. The faster your team can transition goal side the better will be your defensive record.

FAST BREAK SOCCER PRACTICE # 4

Warm Up (20 min)

A. Circuit With Partner

1. One touch passing down sideline.
2. One touch passing across field, one player running forward, other runs backwards.
3. Two touch passing down sideline
4. X, running forward, throws ball to partner running backwards who heads it back.

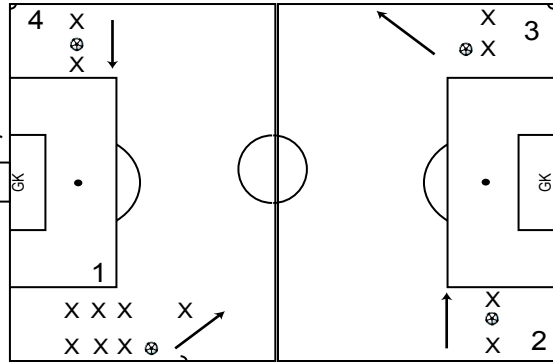

C. Repeat Circuit

B. Runner's & Hamstring Stretches

D. Quad & Personal Stretches

Transition Play (30 min)

Teams A/B play against each other inside 15m x 15m grid.

Each team has a player in opposing 3m deep endzones.

1. Players must pass into either endzone from within 2m.
2. Players sprint into endzone to replace player they passed to.
3. Endzone player breaks out fast to start his team playing into opposite endzone.

If B wins ball inside grid, they immediately play to player in one of their endzones

1 pt for each successful pass into endzone. Team w. 10 pts wins.

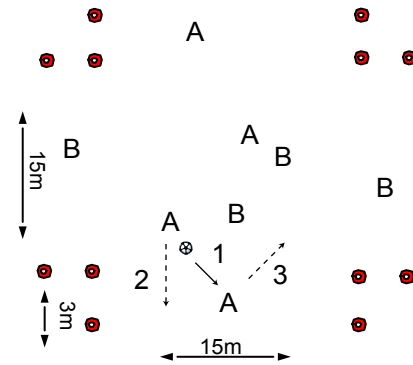

Soccer Speed (10 min)

1. Players sprint 20 m to ball
2. Player speed dribble 20 m and stop ball right on line
3. Slow dribble back to deposit ball on center line
4. Slow jog back to starting line. 8 reps per player.

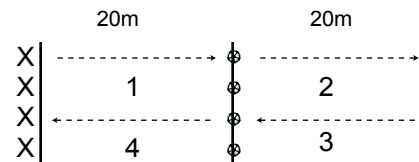

Goal Scoring (30 min)

1. 3 groups (A,B,D) play 3v1 inside 10m x 10m grids
2. Groups A/B alternate sending a player to the corner with a pass.
3. Player sent to corner crosses to group C.
4. Group C plays 3v1 on goal

After 3 minutes groups rotate position clockwise.

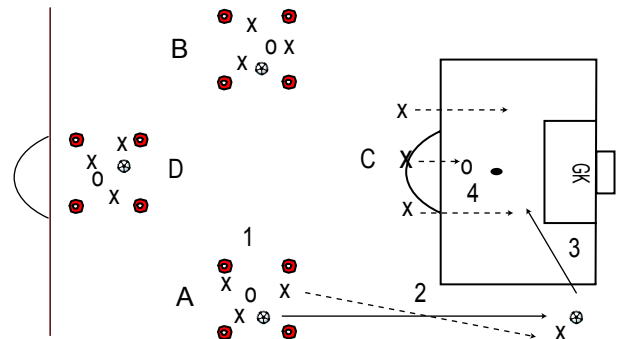

Game Tactics (30 min)

Two lanes are marked along each side of the field. Team A plays left to right and B right to left. Each team has a player in one of their defending lanes (A1,B1) and in one of their attacking lanes (A2, B2). Lane players cannot cross the center line and no other players can enter lanes.

1. After winning possession, teams must play into a lane. In the diagram, A won ball in their own half and plays to A1.
2. A now transitions to attack and play is switched.
3. Pass is played through as few players as possible to opposite lane.
4. Team A now attacks goal

If team wins ball in opponent's half, they play directly to attacking lane.

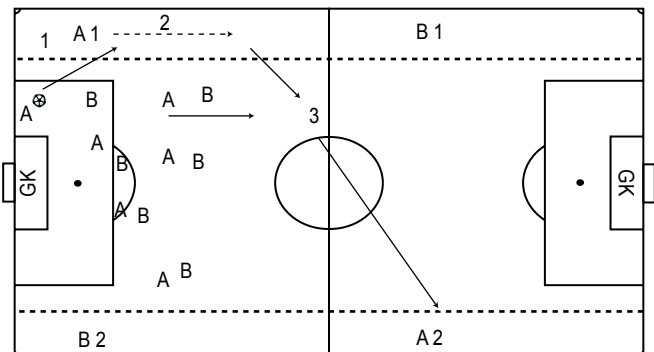

Players should be busy at all times. If drills keep players inactive, break team into smaller groups and run parallel drills.

FAST BREAK SOCCER WARM UP # 4

Circuit - Passing & Heading

A. Circuit With Partner

1. One touch passing down sideline.
2. One touch passing across field, one player running forward, other runs backwards.
3. Two touch passing down sideline
4. X, running forward, throws ball to partner running backwards who heads it back.

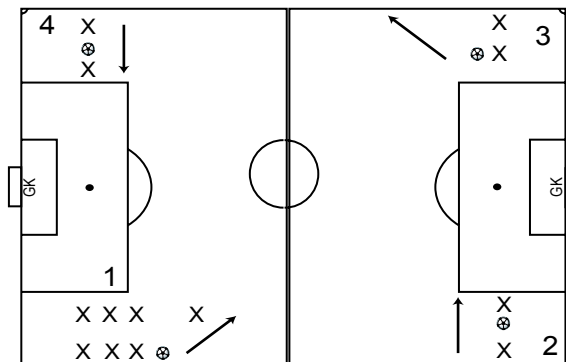

B. Runner's & Hamstring Stretches

C. Repeat Circuit

D. Quad & Personal Stretches

Coaching Points

Circuit station 1: Passes must be diagonal into run of partner. Weight of pass must be such that players can run at a steady pace - no sprinting, no waiting for pass. Requires paying attention to partner's pace and capability.

Circuit station 2: Keep distance between players fairly constant. Again, weight of pass to keep steady pace is key.

Circuit station 3: The first touch must be controlled to set up the pass with second touch. This should allow players to perfect the one touch passing from station 1.

Circuit station 4: Time throw for header to allow player running backwards to arch back and put power into header.

Try to pair players close to how they would play together in a game.

Game Application

The passing drills are essential soccer building blocks applicable to any game situation. However, executing them in a warm-up without pressure allows players to practice perfection and also to get used to each other's pace, skills and preferences.

The drills where one partner runs backwards trains off-balance soccer skills, very helpful in second chance (second ball), rebound or reactive situations.

FAST BREAK SOCCER TRANSITION PLAY # 4

2 v 2 in a 4 v 4

Teams A/B play against each other inside 15m x 15m grid.

Each team has a player in opposing 3m deep endzones.

1. Players must pass into either endzone from within 2m.
2. Player sprints into endzone to replace player they passed to.
3. Endzone player breaks out fast to start his team playing into opposite endzone.

If B wins ball inside grid, they immediately play to player in one of their endzones

1 pt for each successful pass into endzone. Team w. 10 pts wins.

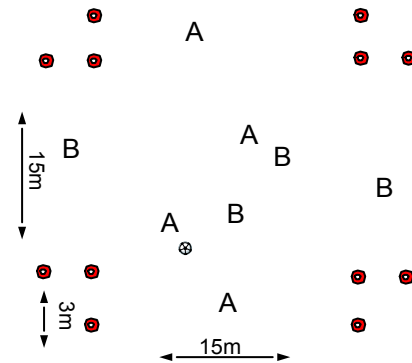

Coaching Points

1. It is important that players with possession get within 2m of the endzone to pass to team mate and release them. This forces players to work the 2v2 with short passes or 1v1s as opposed to long balls into the endzone.
2. The player in the endzone must read the play and move laterally to be in a good position to receive the pass.
3. Players in endzone have a good vision of play and can help team mates engaged in 2v2 with positive communication.
4. Players in endzone receiving ball must break out quickly and decide before they receive the ball what they will do next, pass to team mate or dribble, as well as direction of play. Direction should be into space.
5. The team mate of the player who passed into the endzone must get into position and be prepared to attack opposite goal.
6. If defending team wins ball in grid, they can attack either endzone.
7. Make up teams based on how they are likely to combine with each other in a game.

Game Application

Passing to a team mate who then passes or dribbles in the direction they received the ball from occurs mostly when playing laterally across the field. It also applies to passing to an attacker with their back to goal being covered by an opposing defender. The attacker may play the ball away from the defender before turning or passing to a team mate. Winning possession and accelerating play into another direction to open up space and catch the opponent off-balance is a key element of soccer.

The major benefit from this transition drill is to get players to think of varying play directionally, to anticipate passes, to make fast decisions and to work together in small groups.

FAST BREAK SOCCER SPEED # 4

Sprint & Speed Dribble

1. Players sprint 20 m to ball
2. Player speed dribble 20 m and stop ball right on line
3. Slow dribble back to deposit ball on center line
4. Slow jog back to starting line.

8 reps per player.

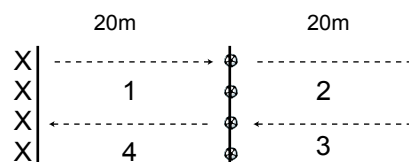

Coaching Points

1. Players must slow down before their first touch on ball to set up proper control and direction.
2. After the first touch, they accelerate as fast as possible into high pace dribble.
3. Slow down before reaching end line and ask for perfection when stopping the ball on the line after dribble.
4. Nice tight ball control dribble to return ball to center line.
5. Easy jog to starting point.
6. Ask players to stay as much in line with each other as possible - this is not a race.

Use at least one of the natural field lines if the field is marked, and make it the center line so that balls always are in same spot prior to dribble.

Game Application

Short sprints to a ball, to receive a pass or to close down an opponent are common. High paced dribbles while keeping control and changing direction are the signs of excellence. The key to control is to slow down the final steps of a dribble prior to changing direction or beating an opponent with a 1v1 move. After a change of direction quick acceleration is the best way to now lose the opposing player.

FAST BREAK SOCCER GOAL SCORING # 4

3 v 1 with Crossing

1. 3 groups (A,B,D) play 3v1 inside 10m x 10m grids
2. Groups A/B alternate sending a player to the corner with a pass.
3. Player sent to corner crosses to group C.
4. Group C plays 3v1 on goal

After 3 minutes groups rotate position clockwise.

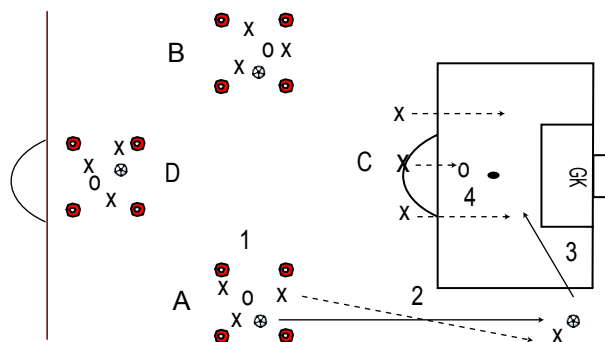

Coaching Points

1. Players in the groups ready to send a player must communicate so that player being sent knows.
2. Player going for cross must sprint and then set up cross with a last diagonal touch so that player faces target area just before crossing.
3. Players waiting for cross must always move (not stand and wait) to lose defender. Once they see cross coming they time their runs for a direct shot or header (delay runs if necessary so that the cross doesn't go into their backs. They need to react to the crossed ball, not anticipate it.
4. If direct shot/header is not possible, then receive ball and quickly set up team mate for a shot.
5. Once attack is complete, everyone resets very quickly to start cross from other side.
6. Players in groups not involved in cross play a regular 3v1. If defender gains possession, they give ball back to attackers.
7. Remind players that target areas for crosses are top of 5m box parallel to goal posts and penalty spot.

Group your players based on your game formation. For example, each group could have a defender, one attacker and two midfielders.

Game Application

Releasing a player into space for a cross into target areas is a key building block of attacking play. It is important to cross from as close to goal line as possible such that the cross is away from goalkeeper and into back of defenders. Strikers are most successful when reacting to cross and sprint to ball for a power header or shot. It is very difficult for defenders to react to an attacker coming in at full speed.

The 3v1 sets up angled passes, runs and positions to open up spaces.

FAST BREAK SOCCER GAME TACTICS # 4

8 v 8 Switching Play

Two lanes are marked along each side of the field. Team A plays left to right and B right to left. Each team has a player in one of their defending lanes (A1,B1) and in one of their attacking lanes (A2, B2). Lane players cannot cross the center line and no other players can enter lanes.

1. After winning possession, teams must play into a lane. In the diagram, A won ball in their own half and plays to A1.
2. A now transitions to attack and play is switched.
3. Pass is played through as few players as possible to opposite lane.
4. Team A now attacks goal

If team wins ball in opponent's half, they play directly to attacking lane.

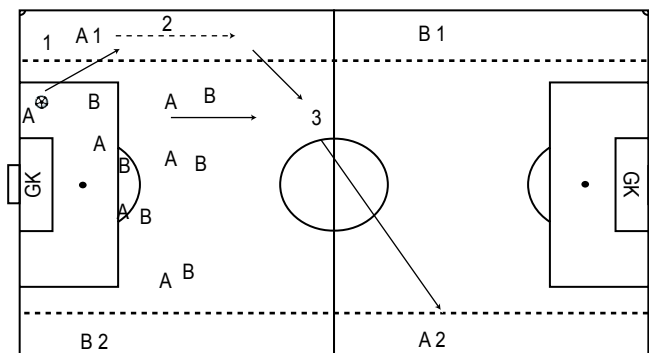

Coaching Points

1. Players in lanes must move with the play to be in position to receive ball.
2. Lane players receiving ball in their own half must look for open players to play ball out as quickly as possible. They can take a short dribble but must be aware that they cannot cross center line. They do not want to stand with ball waiting for team mates to open up. If no short pass is available, they can attempt to switch play across field to diagonally opposite team mate.
3. When ball is in defensive lane, team mates must open up quickly for a pass and then switch play across field. Ideally, they will switch with two touches. If necessary, they can make one more pass to a team mate.
4. After ball is in attacking wide lane and played back into field, regular attacking play starts. Teams always have the option to play back to player in wide attacking lane.

Excellent opportunity to practice various strategies (offense v. defense; starters vs bench) or to remain with normal positions.

Rule Option: Restrict play to two touches per player

Progression Options:

1. Allow one opposing player to enter the wide lane and challenge lane player
2. Allow lane players to leave lane after they played ball out of it.
3. Do not designate lane players, let team decide "on the fly" who enters lane. Make sure a player is in lane to receive ball at the right time.

Game Application

This drill forces teams to play the ball wide first to open up space and stretch opposing defenses. Fast switching of the side of attack is useful to unbalance opposition and open up crossing opportunities. Having opportunities to play wide and through the middle is a necessary element of a balanced attack. Advanced teams will have players making the wide runs and passes can almost be automatically into space based on the knowledge that a team mate will be in position.

FAST BREAK SOCCER PRACTICE # 5

Warm Up (30 min)

A. Reaction Run

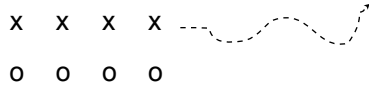

1. Split team into two lines, 5m apart.
2. X's jog in half field changing direction randomly
3. O's mirror x's move keeping distance to x's at 5m
4. Run 2 minutes and reverse role for 2 minutes

B. Runner's & Hamstring Stretches

C. 5 v 2 Passing

1. Two touch passing in 5v2
 2. Attackers (x) get point for completed pass, defenders get point for each win of ball
 3. First group to get 5 points wins and two attackers change roles with defenders.
- Play for 10-12 minutes

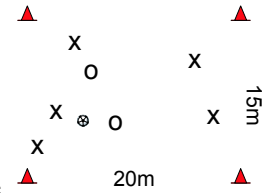

D. Quad & Personal Stretches

Transition Play (30 min)

Field is divided into 3 zones as shown. X attack two small goals and regular goal which O defends. O counterattacks two wide goals at half.

Teams get one point for each goal scored and two points if they score a goal while an opposing player is trapped in one of the outside zones.

The example shown is ideal for a 4-4-2 and/or zonal system and you use 4 midfielders and 2 attackers vs. 4 defenders and 2 midfielders. Adjust number of players on each team to reflect your system of play.

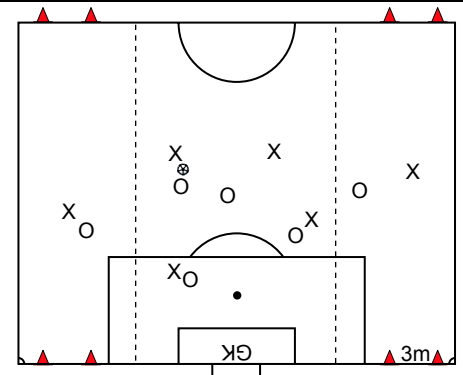

Soccer Speed (10 min)

A. Get Up and Sprint (5min)

1. Players lie flat on the ground with hands near shoulders.
2. On command, they push off hands and feet and sprint 10 m.

B. Jump - Turn - Sprint (5min)

1. Stand facing the goal line.
2. On command, jump, make a 180 turn in air and sprint 10 m in opposite direction

Goal Scoring (30 min)

1. X dribbles towards cone.
2. Just before cone, X passes ball in front of cone.
3. X then sprints around cone to shoot.
4. X shoots aiming for far post.
5. O passes a ball to X and sprints to close down X. X now plays 1v1 on goal.

After 1v1 X goes to back of line O and O to back of line X. Set up a second drill on a goal with dribble, shot and O from other side of goal to practice left footed shots. Switch groups.

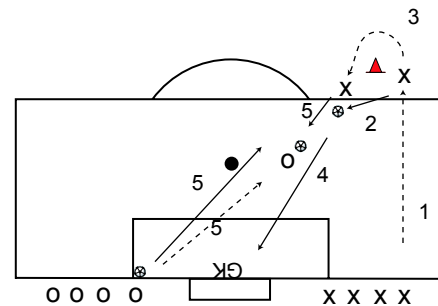

Game Tactics (20 min)

Three teams play on four full size goals with goalkeepers.

X attacks goals A and O attacks goals B.

After a goal is scored or the ball goes out of the area, play restarts with the opposing team (the team that did not score or play ball out) passing it in from their goal line. If the goalie makes a stop and has control of ball, goalie plays ball out to a player of the team that did not take the shot.

Rotate the four goalkeepers with X or O every three minutes.

Have enough balls ready at side lines to keep play moving.

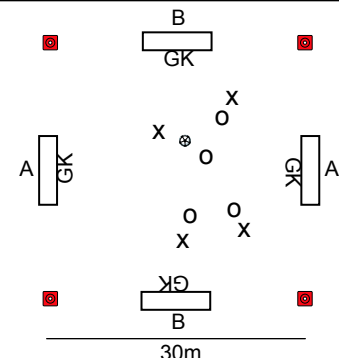

Players should be busy at all times. If drills keep players inactive, break team into smaller groups and run parallel drills.

FAST BREAK SOCCER WARM UP # 5

Reaction Run & 5 v 2 Passing

A. Reaction Run

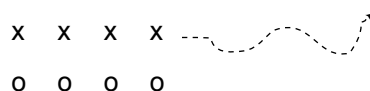

1. Split team into two lines, 5m apart.
2. X's jog in half field changing direction randomly
3. O's mirror x's move keeping distance to x's at 5m
4. Run 2 minutes and reverse role for 2 minutes

B. Runner's & Hamstring Stretches

C. 5v2 Passing

1. Two touch passing in 5v2
2. Attackers (x) get point for completed pass, defenders get point for each win of ball
3. First group to get 5 points wins and two attackers change roles with defenders.

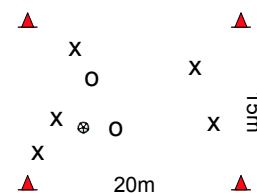

Play for 10-12 minutes.

D. Quad & Personal Stretches

Coaching Points

Reaction Run:

1. Lines must stay intact by keeping distance between x and o and by individual lines staying in tight shape.
2. If players are doing a good job, add a progression by having the last player in each line run a little faster to get in front of line. This player now leads if they are in the direction setting group.
3. Keep the pace at a light jog and focus on technical execution.

5v2 Passing:

1. Attacking team must be in constant motion and open up at least 3 passing options for player with possession
2. Encourage attackers to look for passes between (splitting) the two defenders
3. Defenders need to follow standard practice for first and second defenders - first defender challenges, second defender covers and looks to cut off passing lanes.
4. If neither team gets to five points within 2 minutes, stop the drill and offer suggestions, then rotate players.
5. Coach can change the scoring system based on ability of team. For example, attackers get one point for each set of five consecutive passes.

Game Application

The reaction run replicates marking of an opposing player and reacting to their movements. Keeping distances constant trains perception and vision, as well as the ability to concentrate on own task while keeping the game in peripheral vision. Should improve players ability to eventually dribble with head up.

The 5v2 allows two touch passing with limited pressure. Players learn to be in constant motion looking to get into position to support the ball carrier and increase success rate of the pass. Splitting the defenders is a great way to penetrate a defense. Defenders learn to anticipate runs and passes and to close down passing options.

FAST BREAK SOCCER TRANSITION PLAY # 5

7 v 7 on 5 goals

Field is divided into 3 zones as shown. X attack two small goals and regular goal which O defends. O counterattacks two wide goals at half.

Teams get one point for each goal scored and two points if they score a goal while an opposing player is trapped in one of the outside zones.

The example shown is ideal for a 4-4-2 and/or zonal system and you use 4 midfielders and 2 attackers vs. 4 defenders and 2 midfielders. Adjust number of players on each team to reflect your system of play.

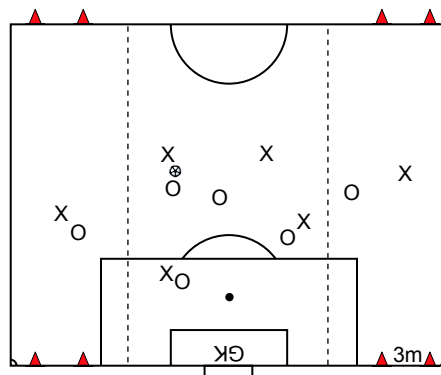

Coaching Points

1. Players will tend to play this drill like a regular game - seeking to score on the regular (center) goal
2. Encourage them to play to the wide goals.
3. Reinforce the reason for getting two points while an opposing player is trapped in one of the outside zones: to encourage a fast switch of play or point of attack.
4. After gaining possession of ball, the new attacking team needs to transition as fast as possible and with the least amount of team touches to score a goal.
5. The team now playing defense needs to sprint into defensive positions (goal side) and one player must immediately pressure the opposing ball carrier.
6. Encourage two touch soccer.
7. Adapt the number of players to your team's system of play. One team should be made up of your attacking players (strikers and attacking midfielders - or all midfielders) and the other of defenders and defensive midfielders.

Game Application

Teams need options for attacking by opening up spaces. While ultimately playing on goal to get in a position for shots, switching the play quickly across the field while moving forward unbalances the opponents and opens up play. It requires a lot of coordination, communication, perception, vision and anticipation. This drill trains the combination of what is often called "vertical" and "horizontal" play.

FAST BREAK SOCCER SPEED # 5

Short Sprints After Flexstarts

A. Get Up and Sprint (5min)

1. Players lie flat on the ground with hands near shoulders.
2. On command, they push off hands and feet and sprint 10 m.

B. Jump - Turn - Sprint (5min)

1. Stand facing the goal line.
2. On command, jump, make a 180 turn in the air, and sprint 10 m in opposite direction

Coaching Points

1. Have all players face the same direction and start in line so you can observe those with quickest reaction.
2. Emphasize to players that they are training reaction (to command), flexibility (the initial move) and short distance speed.
3. Ask for perfection, i.e. all players have proper starting position in line and sprint in the exact direction required.

Game Application

Being on ground and recovering quickly is a frequent game need. Being down, getting up quickly and knowing where to sprint makes your team's game that much faster. Turning in the air and sprinting in the opposite direction trains rotational flexibility useful in any change of direction move with or without the ball.

FAST BREAK SOCCER GOAL SCORING # 5

Dribble - Shoot - 1 v 1

1. X dribbles towards cone.
2. Just before cone, X passes ball in front of cone.
3. X then sprints around cone to shoot.
4. X shoots aiming for far post.
5. O passes a ball to X and sprints to close down X. X now plays 1v1 on goal.

After 1v1 X goes to back of line O and O to back of line X.
Set up a second drill on a goal with dribble, shot and O from other side of goal to practice left footed shots. Switch groups.

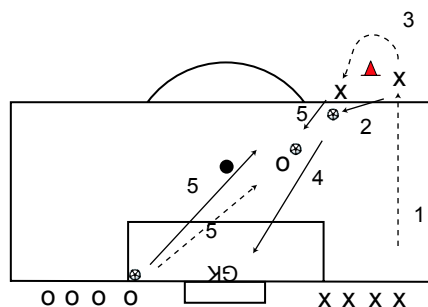

Coaching Points

1. Tightly control dribble to cone and encourage players to keep head up looking at cone.
Dribble should be at highest speed while maintaining close control until player gets ready for pass.
2. Pass in front of cone should be at a slight diagonal forward to set up a good first touch shot.
3. Players need to time the pass in front of cone and their sprint around cone to strike a still moving ball.
4. O must pass right after X has taken a shot and weight the pass hard enough to get to X fast but not so hard that X cannot control it. Pass must be on ground and to feet of X.
5. O must follow their pass immediately to close down X such that X cannot take a one touch shoot but must play 1v1.
6. Allow no more than 10 seconds of the 1v1 to get a shot away.

Game Application

Dribbling with head up, and touching ball diagonally forward for a strike on a moving ball are essential skills of strikers. Receiving the second pass from O simulates a rebound and requires the striker to stay focussed after the shot, always perceiving the environment. The second pass also forces the attacker to make a quick decision: Do I shoot or go 1v1? Defenders need to close down strikers quickly. Passing and following your pass or moving into space after a pass are key techniques of modern soccer.

FAST BREAK SOCCER GAME TACTICS # 5

4 v 4 on 4 Goals

Three teams play on four full size goals with goalkeepers.

X attacks goals A and O attacks goals B.

After a goal is scored or the ball goes out of the area, play restarts with the opposing team (the team that did not score or play ball out) passing it in from their goal line. If the goalie makes a stop and has control of ball, goalie plays ball out to a player of the team that did not take the shot.

Rotate the four goalkeepers with X or O every three minutes.

Have enough balls ready at side lines to keep play moving.

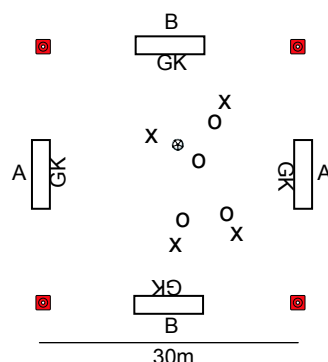

Coaching Points

1. Remind players that they can reverse direction and attack the goal currently in their back.
2. Encourage to shoot frequently.
3. Emphasize two touch passing.
4. If a team gains possession, they need to transition quickly to attack goals in a different direction than just played.
5. Attackers must transition quickly to defense after loss of possession.
6. Have enough balls distributed at each side line to keep the play moving, especially if you are using cones as goals.
7. Stress quick decision making after gaining possession in terms of which goal to attack.

Game Application

At times the attacking team gets bogged down in forward movement and must reverse play. It is important that this reversal is executed fast and for a very brief period of time. The purpose is to draw defenders out, open up space, then quickly reverse direction again to attack goal. Players need to read the play and the signals of their team mates to move as a unit and to anticipate the next plays.

Having to attack goals in a 90 degree direction from the previous play is good training for switching play across the field after having just gained possession.

FAST BREAK SOCCER PRACTICE # 6

Warm Up (30 min)

A. Agility Jog

1. Easy jog
2. Sideway shuttle
3. Easy jog with three complete turns, alternate direction
4. Jog and jump for header every 5m

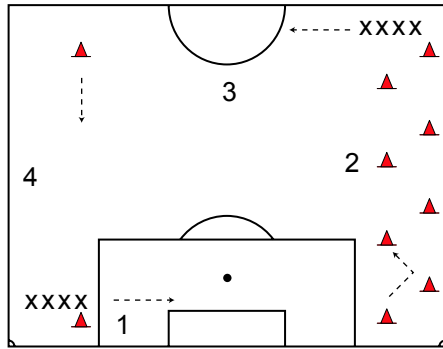

B. Runner's & Hamstring Stretches

C. Anticipation Passing

1. A plays give and go with B to the open cone. At the same time
2. C passes to D
3. This is how the situation looks after the first set of passes. Now D plays give and go with B while A passes to C, and so on.

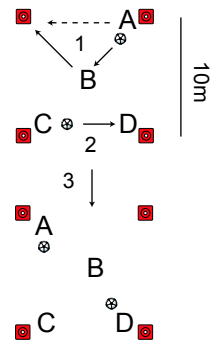

D. Quad & Personal Stretches

Transition Play (20 min)

- Play on a field twice the size of penalty box.
1. X1/O1 and X2/O2 stay in their half of field.
 2. Start play with X1 who must play a pass to X2 in other half. Should O1 win ball, then O1 must play pass to O2.
 3. X2/O2 now play 1v1 on goal, with the player who received the pass (say X2) being the attacker, and the other player (say O2) defending.
 4. If O2 wins possession, O2 passes to O1 who now attacks goal defended by X1. If a goal is scored, ball goes out of bounds or GK makes a save, play restarts with GK playing ball across into other half to O2.
- Play for 2 minutes and then change teams with those waiting near goal.

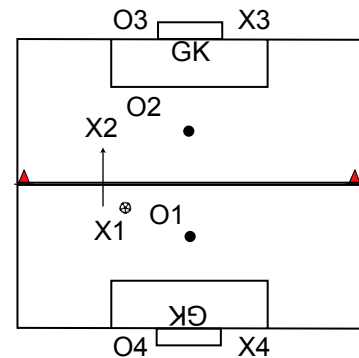

Soccer Speed (10 min)

1. Players jog for approximately 20 m.
2. On coach's command, players turn and sprint to their ball.
3. Players now speed dribble to an endline 20 m away.
4. They then slow dribble ball back to center and restart

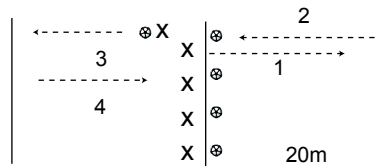

Goal Scoring (30 min)

1. A passes through two 2m wide goals (3m apart) to B positioned at one end of 3rd goal whose posts line up with far edges of 6 yd box. A follows own pass running through goals.
2. B one touch lays off ball to player C positioned at opposite post of large goal. B follows pass and stops in center of large goal.
3. C one touch passes to A.
4. A now plays 1v1 against B and once past B goes for shot. B must stay on goal line of large goal.

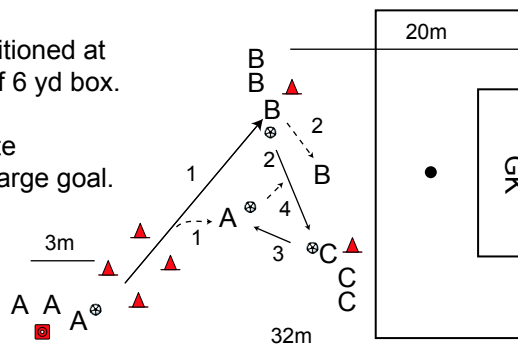

After play, A goes to line B, B to C and C to A.

Game Tactics (30 min)

- 4v4 with neutral players along the sidelines in each half.
- The team in possession can use neutral players.
- Play quick passes into corners for crosses and finishing.
- Rotate teams (X, O, N) every three minutes.

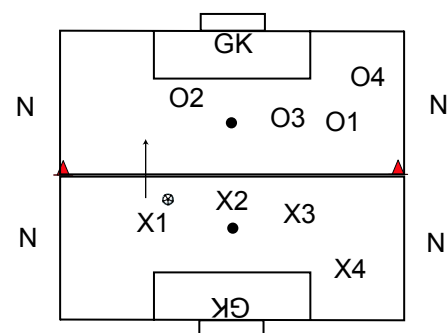

Players should be busy at all times. If drills keep players inactive, break team into smaller groups and run parallel drills.
Copyright 2008 by Sauder Consulting Inc.

FAST BREAK SOCCER WARM UP # 6

Agility Jog & Anticipation Passing

A. Agility Jog

1. Easy jog
2. Sideway shuttle
3. Easy jog with three complete turns, alternate direction
4. Jog and jump for header every 5m

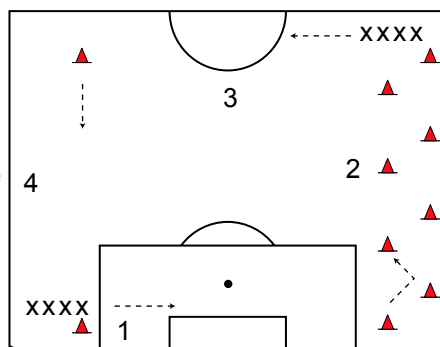

B. Runner's & Hamstring Stretches

C. Anticipation Passing

1. A plays give and go with B to the open cone. At the same time
2. C passes to D
3. This is how the situation looks after the first set of passes. Now D plays give and go with B while A passes to C, and so on.

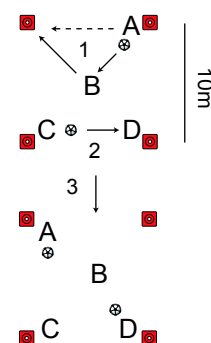

D. Quad & Personal Stretches

Coaching Points

Organization Options:

Divide your team into four groups and

- a. do agility jog on half field with one group starting at each station **OR**
- b. set up circuit in each half of the field, two groups per circuit **OR**
- c. set up circuit with two groups in one half of field and two passing drills in other half of field and run drills simultaneously, switching groups after the first set of stretches.

Agility Jog:

1. ensure players concentrate on the pace of the run and proper intervals between turns (station 3) and headers (4).
2. the sideways shuttle at station 2 requires fluid body rotation between cones, ensure players get close to cones.

Anticipation Passing:

1. the give and go (A&B) must be timed precisely with the pass (C to D) such that A arrives at the open cone at the same time that the pass from C arrives at D.
2. All passes are one touch.
3. After playing the pass to open cone, B must turn and be ready to receive the next give and go pass from D
4. Rotate players through the "B" position.
5. Players must get to the point where the drill is fluid with continuous passing and movement - "poetry in motion"

Game Application

Agility to turn while running, timing running distance, timing jumps and getting a good feel for running speed and distance are critical physical and mental building blocks for individual excellence. These abilities support fast break attacking soccer styles.

The ability to precisely time one touch "give and go" passes with the proper weight will break open opposing defenses. The importance of precision pass direction, pass weight, and timing of runs cannot be stressed enough. Being able to adjust to new impulses after playing a pass (like player B does) is a critical perception and anticipation skill. These building blocks will lead your team to play faster and give your opponent less time to react. Hence your team will start to dominate the game.

FAST BREAK SOCCER TRANSITION PLAY # 6

Two 1 v 1 Across Two Fields

Play on a field twice the size of penalty box.

1. X1/O1 and X2/O2 stay in their half of field.
2. Start play with X1 who must play a pass to X2 in other half. Should O1 win ball, then O1 must play pass to O2.
3. X2/O2 now play 1v1 on goal with the player who received the pass (say X2) being the attacker and the other player (say O2) defending.
4. If O2 wins possession, O2 passes to O1 who now attacks goal defended by X1. If a goal is scored, ball goes out of bounds or GK makes a save, play restarts with GK playing ball across into other half to O2. (always to team who last touched the ball)

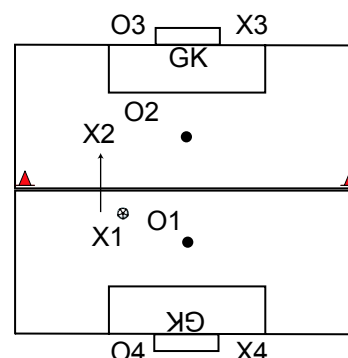

Play for 2 minutes and then change teams with those waiting near goal.

Coaching Points

1. The focus is on getting as many shots on goal as possible in the 2 minute time frame.
2. The transition happens after change of possession from either the defender or the goalkeeper playing ball into other half.
3. It is critical that the transition happens super fast. Have extra balls at each goal.
4. For the fast transition, the players waiting in the other half must be alert and anticipate the change of possession. They know who will be the attacker and who will be the defender after the transition pass or throw. The player who will be the attacker must always be in open space or be prepared to move into space to receive the transition ball.
5. Stop play if players are confused or are not transitioning fast enough.
6. If the transition pass gets to the right player, the attacker must set up a shot very quickly, even a first time shot. Remember the attacking play takes place inside the penalty box and you want to get quick shots there. Discourage extended 1v1 "battles".
7. The player defending the transition play needs to anticipate the play. Should they get possession before the target attacking player, they must play across to their partner who will attack the goal in their half.

It is important for coaching instructions to be clear at the beginning of the drill.

Game Application

When the opposing team has possession everyone on your team is a defending player and works to gain possession. Regardless of where your team gains possession, players not engaged in the immediate play must not only cover opposing players but also anticipate change of possession and moving into space for a fast break attack. This will catch opponents off balance and set up scoring chances.

Once your team plays into the opposing penalty box, emphasize setting up shots quickly and taking them.

FAST BREAK SOCCER SPEED # 6

Reaction Sprints & Speed Dribble

1. Players jog for approximately 20 m.
2. On coach's command, players turn and sprint to their ball.
3. Players now speed dribble it to an endline 20 m away.
4. They then slow dribble ball back to center and restart

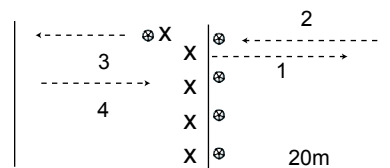

Coaching Points

1. Keep players in line when jogging. This will require them to look and beware of other's position.
2. Recommend using whistle as the command to turn and sprint.
3. Players must turn by pivoting on the spot - do not turn by running a small loop.
4. Players must "explode" into sprint after turn - fast acceleration.
5. The first touch of the ball prior to dribble must be soft to set up ball control and straight line dribble.
Watch for erratic first touches. The key is to slow down the sprint just before the first touch.
6. Keep tight control during speed dribble.

Game Application

The running part of a soccer game is a constant interchange of jogging with short and occasional long sprints. Often players are being covered (trailed/followed) while jogging. A quick change of direction and sprint is a proven way of losing the covering opponent. The sprints should be into space to receive a pass or attack a loose ball. The ability to control the ball after a full sprint and dribble or pass immediately is a fundamental skill that cannot be practiced enough. As your team and players move up the competition ladder to ultimately the professional level, the pace of the game increases, time to control the ball decreases and the execution of sprint-ball control gets more difficult.

FAST BREAK SOCCER GOAL SCORING # 6

3 One Touch Passes & 1v1 on Goal

1. A passes through two 2m wide goals (3m apart) to B positioned at one end of 3rd goal whose posts line up with far edges of 6 yd box. A follows pass running through goals.
2. B one touch lays off ball to player C positioned at opposite post of large goal. B follows pass and stops in center in large goal.
3. C one touch passes to A.
4. A now plays 1v1 against B and once past B goes for shot. B must stay on goal line of large goal.

After play, A goes to line B, B to C and C to A.

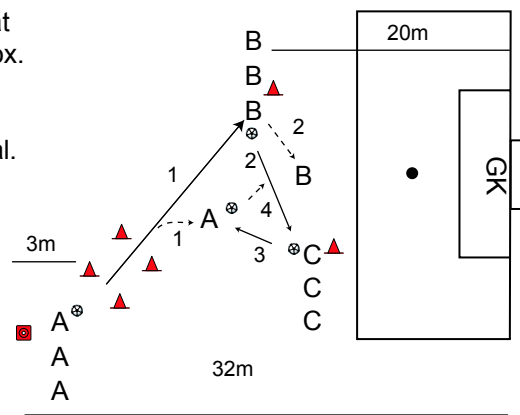

Coaching Points

1. The key is that at the end of the three passes A does not have to wait for ball from C.
2. A must pass very hard to B. If a one touch pass doesn't generate enough power then ask A to play a soft diagonal touch forward first and then strike a moving ball on the ground, through the two small goals.
3. B and C must be ready, on their toes, to receive ball and play a one touch accurate pass.
4. A paces run so that they are always in motion, even if it means a slow jog. The goal for A is to receive the ball from C while moving towards the large goal defended by B.
5. B must accelerate into 1v1 vs B after receiving pass and make a quick move to get past B.
6. B should attack large goal at center to leave option of faking past B on either side.
7. Once past B, A should set up for a shot from the top of the box.
8. Players tend to have head down, looking at ball in the 1v1. They must look up at goal prior to shot.
9. Coach may need to adjust distances to allow proper timing of passes and runs.

Game Application

This drill is a variation of the professional and popular "third man running" play. This play involves three players and ends with the player who started the passing sequence in possession. The quick passing and timed runs will break open defenses. It is best used close to goal to set up a shot. It is effective against flat back defenses since the run from player A comes from a deep position. This drill also trains ever important precision passing through small goals and then to target players. Being able to shoot immediately after beating an opponent near the penalty box is vital.

FAST BREAK SOCCER GAME TACTICS # 6

4 + 4N v. 4 Flank Attack

4v4 with neutral players along the sidelines in each half.

The team in possession can use neutral players.

Play quick passes into corners for crosses and finishing.

Rotate teams (X, O, N) every three minutes.

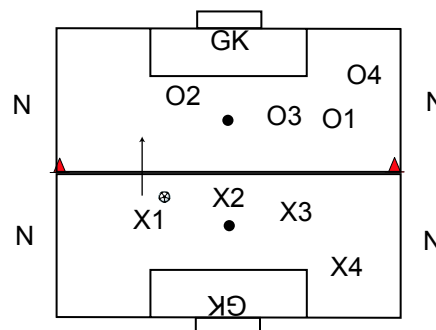

Coaching Points

1. Team in possession seeks to play quickly to Neutral in attacking half to spread defense.
On occasion, attacking team needs to play through middle to vary point of attack and set up faster shots.
2. When defending team wins possession it must transition fast to attack in other half.
3. After losing possession, attacking team must quickly challenge player with ball and cover all other attackers goalside.
4. If you have extra players, set up two drills and remove neutral players if necessary. In that case allow one of the attacking players to go wide outside field of play for crosses.
5. Neutral players or wide players cannot be challenged outside the field.
6. Make up teams according to your system of play. Use outside midfielders/defenders as Neutrals and play midfielders/strikers against defensive players. Use other combinations at your leisure, such as "vertical" teams consisting of defender/attacker/midfielders.

Game Application

Playing a wide outlet pass as the first transition play after gaining possession spreads the opposing defense out and opens up the field of play. Space should open up in the middle for penetrating runs by attackers to get to the end of a cross. This particular drill focusses on gaining possession in the attacking 1/3 of the field. Therefore, mixing up wide plays and plays through the center decreases the predictability of your attack.

FAST BREAK SOCCER PRACTICE # 7

Warm Up (20 min)

A. Dribble & Pass

Half of the players have a ball. All other players spread themselves around the penalty box and stand with legs apart. Players with ball dribble, approach a standing player and pass through open legs. They run around player, collect their pass and approach next player. Switch roles after each player has completed a round.

B. Runner's & hamstring stretches

C. 1v1 Dribble

Coach (C) turns to face a group of players (say d). Player from group faced and from diagonally opposite group (a) dribble towards coach and pass coach with a 1v1 move.

Coach keeps rotating to face different groups.

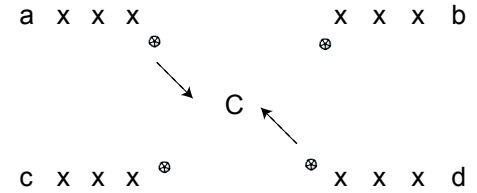

D. Quad & personal stretches

Transition Play (30 min)

One team starts with ball in the middle area of field (X in example shown), and with the starting team attacking a designated goal (left to right)

- X's now play to get into the penalty box. So X1 has the choice of dribbling into the area or, as shown, releasing X2 into it with a pass. Defenders cannot enter penalty box so that attackers always get an unopposed shot on net.
- After X's take a shot, X4 dribbles away from goal line and dribbles or passes ball into the middle and X's now attack opposite goal. If O's win possession in the middle, they attack goal that X4 came from.

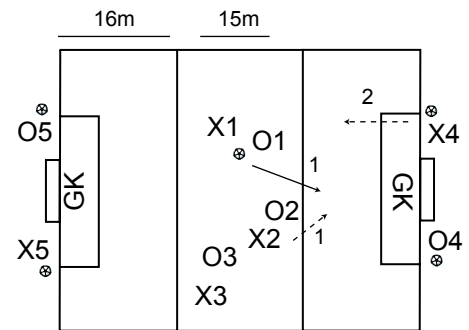

Soccer Speed (10 min)

- X dribbles back and forth between cones trying to beat O to cone.
- X uses cut-backs and pull-backs for fastest change of direction.
- O shadows X and avoids being beaten to cone.
- Reverse roles every 60 seconds.

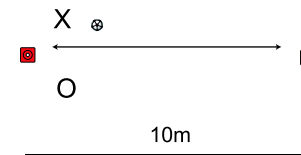

Goal Scoring (20 min)

- X passes diagonally into space ahead of player waiting.
- Wide player controls pass and dribbles around cone near goal line.
- Player now crosses to 2 strikers who attack ball for a one time finish.

Alternate sides of crosses.

Players return to starting position after each attempt.
Rotate positions every 5 minutes

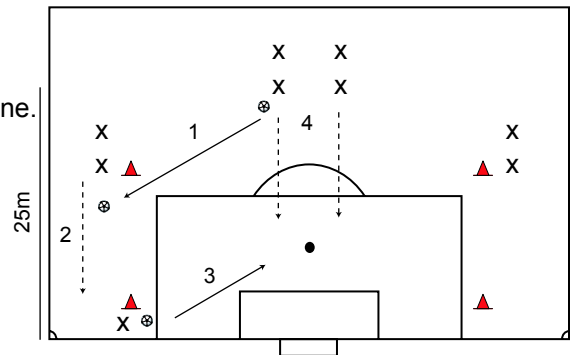

Game Tactics (30 min)

4v4 play on regular size goals with goalkeepers.

Rules:

Teams must play ball into attacking half first.

Then team must play ball back into own half to a team mate who goes for a one time shot.

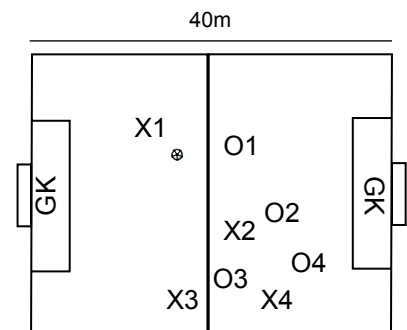

Players should be busy at all times. If drills keep players inactive, break team into smaller groups and run parallel drills.
Copyright 2008 by Sauder Consulting Inc.

FAST BREAK SOCCER WARM UP # 7

Dribble, Pass, 1 v 1 Moves

A. Dribble & Pass

Half of the players have a ball. All other players spread themselves around the penalty box and stand with legs apart. Players with ball dribble, approach a standing player and pass through open legs. They run around player, collect their pass and approach next player. Switch roles after each player has completed a round.

B. Runner's & Hamstring Stretches

C. 1v1 Dribble

Coach (C) turns to face a group of players (say d). Player from group faced and from diagonally opposite group (a) dribble towards coach and pass coach with a 1v1 move.

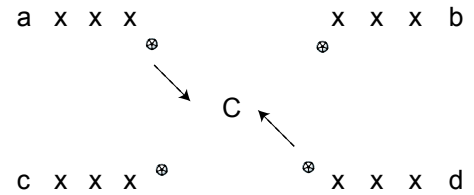

Coach keeps rotating to face different groups.

D. Quad & Personal Stretches

Coaching Points

Dribble & Pass:

1. Players must dribble as fast as they can while maintaining control.
2. Just before passing, slow down dribble and look up at target (open legs).
3. Weight of pass must be enough to allow passer to run past player and collect ball that is still moving !
4. Once ball is collected from pass, pick up speed of dribble.

1v1 Dribble:

1. Players must react quickly to coach's move.
2. Heads up dribble to see direction of opposite dribbler to avoid collision.
3. Vary moves used to get past coach.
4. Slow down just prior to move and pick up speed for dribble after.

Game Application

High paced dribbles while keeping control of the ball set up 1v1 moves to beat opponents or open up space. Dribbling and passing around opponent and then sprinting by same opponent is just one of many 1v1 moves.

1v1 moves are most effective in attacking third to set up penetrating passes, crosses or shots.

The second drill also trains reaction speed - players perceiving motion and making a decision to act.

FAST BREAK SOCCER TRANSITION PLAY # 7

3 v 3 with Shot on Goal

One team starts with ball in the middle area of field (X in example shown), and with the starting team attacking a designated goal (left to right)

1. X's now play to get into the penalty box. So X1 has the choice of dribbling into the area or, as shown, releasing X2 into it with a pass. Defenders cannot enter penalty box so that attackers always get an unopposed shot on net.
2. After X's take a shot, X4 dribbles away from goal line and dribbles or passes ball into the middle and X's now attack opposite goal.

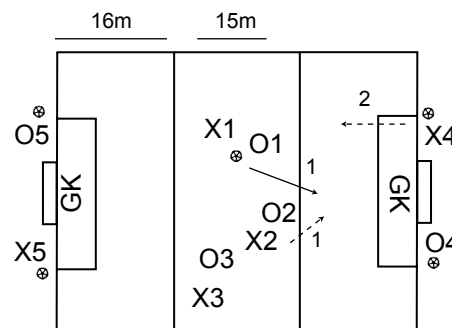

If O's win possession in the middle, they attack goal that X4 came from.

If O's win possession in middle and X's win it back, X's also attack goal X4 came from.

Coaching Points

1. Team in possession in middle third must make quick decision to get one player into attacking area.
2. Encourage two touch passing to release a player quickly, ask for no more than three passes before releasing a player.
3. Ask players to make decisions quickly and encourage a 1v1 to pass an opponent for a dribble into attacking area if defender has no cover behind him.
4. Players on team in possession who don't have ball must move constantly to receive pass and signal fast penetrating runs into attacking area.
5. After shot on goal, player from shooting team must immediately dribble towards middle. Player who took shot must get a ball quickly and be in position next to goal as soon as possible.
6. Do not allow players to jog into position in step 5 above - always keep pace and intensity high.
7. All players must be in middle area before teams can paly into penalty box.
8. Goalkeepers should be very active and play like in a game, forcing quality passes and shots.
9. Make up teams to be consistent with your team formation and strategy. As a general concept, each team could have 2 defenders, 2 midfielders and 1 striker.

Game Application

This trains playing just outside the penalty box to set up a penetrating pass into the area for a shot or a 1v1 dribble into area. Quick passing and quick decision making are developed. Player with ball must decide: Do I see a pass and a run or do I see an opportunity for a 1v1. Once in the area you want a quick shot. If defenders win the ball, they must transition out of defensive third as quickly as possible. Dribbling is acceptable if there is unopposed space ahead, the preference is a few quick passes while the entire team starts moving up the field.

FAST BREAK SOCCER SPEED # 7

High Speed Change Of Direction Dribble

X dribbles back and forth between cones trying to beat O to cone.

X uses cut-backs and pull-backs for fastest change of direction.

O shadows X and avoids being beaten to cone.

Reverse roles every 60 seconds.

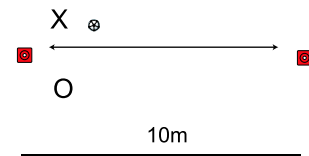

Coaching Points

1. Dribbles must be at highest pace.
2. Ball control must be kept and ball cannot cross line between two players.
3. Change of direction must be fast and crisp, 180 degrees. Fast body rotation.
4. Shadowing players must keep eye on ball.

Game Application

Quick changes of dribbling direction are used mainly to:

- a. "retreat" when dribbling into defenders with little chance of getting through them. A quick turn sets up a pass to a supporting player. Also see "Scoring Drill #7".
- b. To dribble away from traffic into open space to then set up a new attack.
- c. To lose one's marking defender just enough to get a pass away in dangerous and tight spaces.

FAST BREAK SOCCER GOAL SCORING # 7

Crosses and Finishing

1. X passes diagonally into space ahead of player waiting.
2. Wide player controls pass and dribbles around cone near goal line.
3. Player now crosses to 2 strikers who attack ball for a one time finish.

Alternate sides of crosses.

Players return to starting position after each attempt.
Rotate positions every 5 minutes

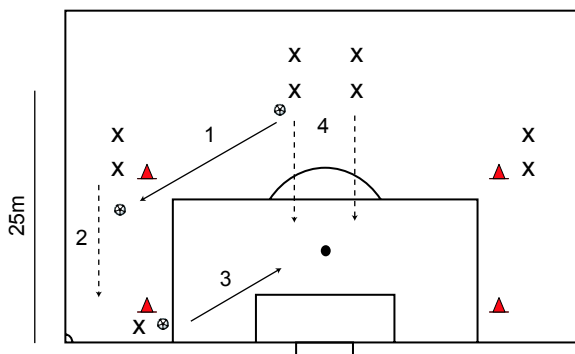

Coaching Points

1. Passes to wide players must be into space. Players must time runs and passes such that runners don't wait for pass, ball doesn't stop before wide players get to it.
2. Speed dribble down the side.
3. Crossing players' last touch should be diagonal towards target area such that player is facing target area.
4. Strikers must delay runs so that they will sprint into cross for shot or header with maximum power. If they run too soon, they will wait for ball, if too late they'll miss it.
5. Crossing players should take ball to goal line before final touch setting up cross.
6. Crossing players should look up at target just before striking the cross.
7. Aim for perfection.
8. If players execute very well, add a defender to challenge the player crossing the ball. This forces attacker to create space to cross. If defender overplays the challenge, then attacker can beat defender before crossing.

Game Application

Diagonal wide passes into back of defense are a great set up for the final cross. Taking the ball as deep as possible before crossing is very effective for unlocking the central defenders. They are either running towards goal, in which case the cross is behind their backs, or they are already in place with their backs to net and they can't see the pass. Either way, they are at a disadvantage to the strikers who have a clear view of the cross and can time their run to arrive at the ball in full speed.

FAST BREAK SOCCER GAME TACTICS # 7

4 v4 With Shot After Lay-Off Pass

4v4 play on regular size goals with goalkeepers.

Rules:

Teams must play ball into attacking half first.

Then team must play ball back into own half to a team mate who goes for a one time shot.

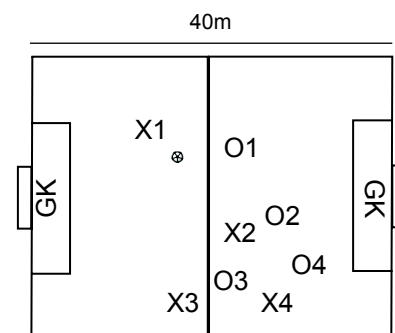

Coaching Points

1. Ideally the pass into attacking zone is to player with back to goal.
2. Players supporting in own half must continuously move to get into position for a shot.
3. Attacking team can pass to each other in attacking half before laying ball back for shot. These must be quick passes and no more than 3. The purpose is to set up a quick shot. A quick dribble with a cut back "retreating" turn for the back pass is acceptable.
4. Upon change of possession, players need to react quickly to pass into attacking zone and set up a shot for their team. The faster the transition, the more likely a good shot.
5. Encourage overlapping runs and third man runs to create and utilize space.

Game Application

This is an effective drill to play ball into penalty box to a striker, who then lays the ball back for a midfielder to take a shot. The midfielder could have made a penetrating run from a deep position.

Strikers often receive ball with back to net and shield defenders so they can pass it back. Or the ball can be played to striker who has possession facing net but is blocked by too many defenders. Striker then turns and passes to supporting player.

These distance shots are difficult for goalkeepers if the play develops fast because there will be a screen and time available for goalkeeper to get set is reduced.

FAST BREAK SOCCER PRACTICE # 8

Warm Up (30 min)

A. Reaction Jog (3 min)

Make up groups of 6 players. They will jog in a line around the field. The first player in each line leads and changes direction randomly. Each player behind reacts to the player in front.

B. Runner's & hamstring stretches

C. Pass & Follow

1. X1 passes to X3 and follows pass.
2. X3 one touch passes back to X1 and
3. X3 runs towards X5
4. X1 passes across into run of X3 and then runs behind X4
5. X3 passes to X5 who one touch passes back to X3. This is the beginning of a new sequence, same as step 1

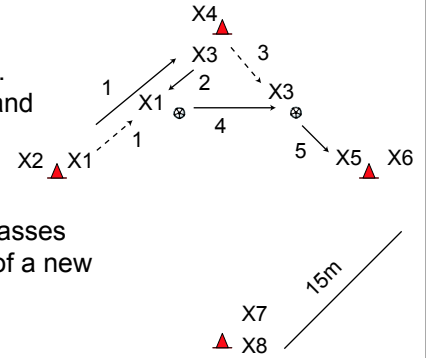

D. Quad & personal stretches

Transition Play (20 min)

Two teams play 5v5 in a grid. You can play up to 8v8 and make the grid larger. Team in possession plays two-touch soccer and tries to maintain possession. Defending team can only win the ball by intercepting a pass, no tackling allowed. Once defending team wins ball, it maintains possession and the other team defends.

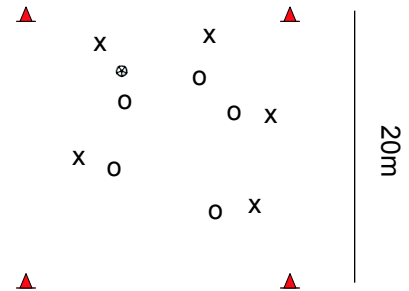

Soccer Speed (15 min)

1. X1 passes to open cone across. X3 sprints from position (a) to open cone (b).
 2. X3 plays ball back to X1 with one touch.
 3. X3 turns and sprints to open cone (c).
4. X3 receive pass from X2
5. X3 passes back to X2, turns and sprints for next pass from X1.
Rotate players every 2 min.

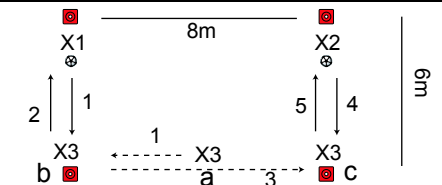

Goal Scoring (30 min)

1. X passes underneath two parallel hurdles to defender D, who is in the middle of a 10m wide goal.
 2. As soon as X passes, X runs and jumps over hurdles.
 3. X turns left or right to receive return pass from defender who has played the ball back with a one-touch pass.
 4. After receiving the ball, X now plays 1v1 against D to get through goal and finish with a shot on net.
- Immediately after shooting, X turns around and takes place of D and gets ready to receive pass from next X. D goes to back of line X.



Game Tactics (25 min)

- 4v4 play.
- Teams score by dribbling balls across line of either goal in opposing end.
- Team that gets scored on restarts play from one of their goals.
- Two touch passing to set up dribble across goal line

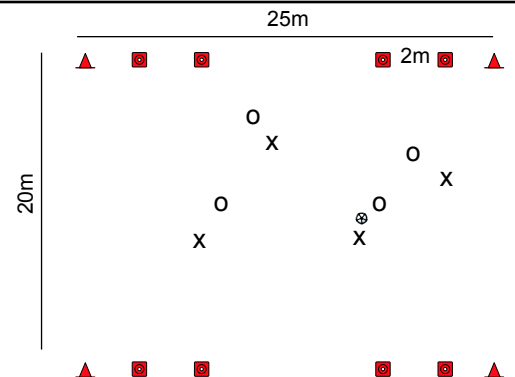

Players should be busy at all times. If drills keep players inactive, break team into smaller groups and run parallel drills.

FAST BREAK SOCCER WARM UP # 8

Reaction Jog - Pass & Follow

A. Reaction Jog (3 min)

Make up groups of 6 players.

They will jog in a line around the field. The first player in each line leads and changes direction randomly. Each player behind reacts to the player in front.

C. Pass & Follow

1. X1 passes to X3 and follows pass.
2. X3 one touch passes back to X1 and
3. X3 runs towards X5
4. X1 passes across into run of X3 and then runs behind X4
5. X3 passes to X5 who one touch passes back to X3. This is the beginning of a new sequence, same as step 1

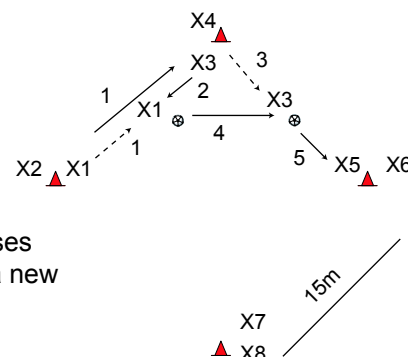

B. Runner's & Hamstring Stretches

D. Quad & Personal Stretches

Coaching Points

The reaction jog is a simple warm-up training reaction speed.

Pass & Follow:

1. The timing of passes and runs must be such that players receive the return pass within 5m, i.e. player X1 is within 5m of X3 when X1 receives the pass back.
2. X3 needs to time the run such that the diagonal pass (4) from X1 is received within 5m from where X3 started. This is important to allow X3 a pass to X5 without being too close.
3. Players must perfect this timing so that the drill runs fluent, without any player ever waiting for a ball, i.e. players must be in motion at all times.
4. Ball must also be in motion at all times.
5. Insist on one touch passing.
6. Reverse direction to practice other foot.

This may take a while to get synchronized - be patient.

If you have more than 16 players, make up two groups.

Game Application

This is a double "give and go" passing play. The first return pass disguises the eventual diagonal run by X3 into space for the return pass. In a game, picture X3 standing with back to a defender, returning the first pass to a facing team mate and then turning and sprinting away from defender for a pass into space.

The one touch passing requirement creates a pace of play difficult to defend against.

A very useful combination play to send one player into an open space past defenders.

FAST BREAK SOCCER TRANSITION PLAY # 8

5 v 5 Pass Interception

Two teams play 5v5 in a grid. You can play up to 8v8 and make the grid larger.

Team in possession plays two-touch soccer and tries to maintain possession.

Defending team can only win the ball by intercepting a pass, no tackling allowed.

Once defending team wins ball, it maintains possession and the other team defends.

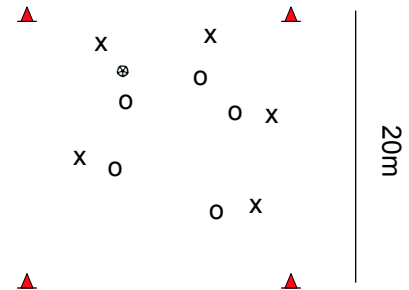

Coaching Points

1. Players must move into space to receive passes.
2. Insist on maximum of two touches to keep up pace of play.
3. Defenders must anticipate passing plays/passing lanes and quickly step in to intercept passes.
4. Change of possession occurs if a defender touches the ball and defenders maintain control.
5. Players in possession need to use all of the space available, watch out for them bunching in corners.
6. Once defending team intercepts pass TRANSITION PLAY occurs. Defenders now need to open up space and start passing. Other team needs to refocus quickly to be ready to anticipate and react to the very next pass. It is critical that this transition happens FAST.
7. Defenders will want to tackle to win the ball. Coach needs to stress that they are to intercept passes ONLY!
8. Winning a ball off a bad first touch is not an interception.
9. Be patient with defenders as this drill may go against their instincts.

It is recommended to put defenders/midfielders and midfielders/strikers together on teams.

Game Application

Quick movement and passing by the team in possession is fundamental to fast break soccer. The more critical component of this particular drill is training your players to read passing options of your opponents, and to get ready to react to a pass and intercept it. All this is happening while the fundamentals of defending - challenging and covering defenders - still apply. This keeps all players not directly involved mentally in the game at all times.

It is equally important for your team to mentally switch from defending to attacking quickly immediately upon gaining possession of the ball. The faster the transition, the more unbalanced the opposing defense.

Anticipation speed is essential to defending in a quick transition game.

FAST BREAK SOCCER SPEED # 8

Give & Go - Turn - Sprint

1. X1 passes to open cone across. X3 sprints from position (a) to open cone (b).
2. X3 plays ball back to X1 with one touch.
3. X3 turns and sprints to open cone (c).
4. X3 receive pass from X2
5. X3 passes back to X2, turns and sprints for next pass from X1.

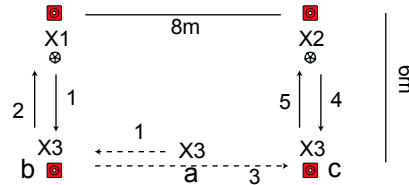

Rotate players every 2 min.

Coaching Points

1. Passes to cones must be accurate and timed to the pace of the sprinter, i.e. arrive at cone same time as runner. Therefore players need to learn each other's speeds.
2. Runner between cones must slow down at cone to play a precision pass back to the player at opposite cone.
3. Runner must pivot 180 degrees as quickly as possible and sprint to opposite cone.
4. Players at cones with balls must retrieve any errand pass quickly and get back in position - they must stay focussed on runs and timing.
5. Sprinting must be with fast, small step acceleration - it is only a short distance.
6. Passers tend to try to make it easier for the running player by slowing the pace. Ask them to lead the runner with the pass to keep the work rate and intensity high. This is critical to fast break soccer.

Game Application

Approaching space at high speed and playing a ball into that space are key components of losing defending players. Returning the ball quickly, turning and sprinting into space to lose defenders is a fundamental combination of fast break soccer. This drill builds the speed required to execute combination plays such as the one shown in the warm-up (8) session of this practice. This drill also trains players to check into space, then quickly turn and sprint into space for a pass.

The speed of runs and passes is forever increasing in modern soccer and time spent with the ball is decreasing.

FAST BREAK SOCCER GOAL SCORING # 8

Pass - Hurdle Sprint - 1 v 1 - Shoot

1. X passes underneath two parallel hurdles to defender D, who is in the middle of a 10m wide goal.
 2. As soon as X passes, X runs and jumps over hurdles.
 3. X turns left or right to receive return pass from defender who has played the ball back with a one-touch pass.
 4. After receiving the ball, X now plays 1v1 against D to get through goal and finish with a shot on net.
- Immediately after shooting, X turns around and takes place of D and gets ready to receive pass from next X. D goes to back of line X.

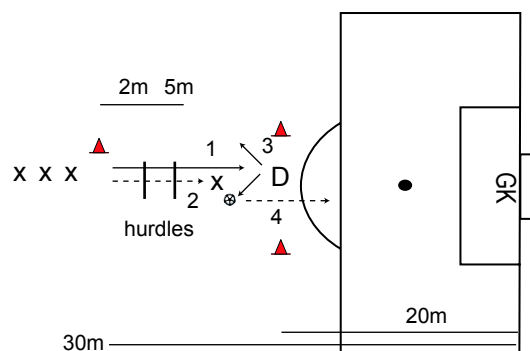

Coaching Points

1. Pass through hurdles must be precise.
2. If you don't have hurdles, mark two small 2m wide goals with cones and ask players to jump over an imaginary hurdle.
3. Defender must weight return pass so that attacker can sprint forward to receive it without waiting or without having to reach behind to get ball.
4. Attacker must control return pass with a good first touch in the direction of the next move. Attacker must decide quickly if defender will be taken on at the near or far post.
5. Do not allow attackers to slow down and "fiddle" prior to 1v1 move. They must decide quickly and then commit to the decision immediately.
6. After the shot, the play for the attacker continues. They now transition immediately to defending role. The defender must clear the goal immediately after the 1v1 is over. Players with a tendency to BALLWATCH will likely stop and watch after they complete their task. Encourage to TRANSITION into their new role without watching the rest of the play.
7. If this transition slows the play too much, you may have a waiting "X" take D's spot to improve flow.

Game Application

The hurdles represent defenders trying to tackle. Jumping over defenders after passing is more effective to keep the play fast than to stop or "dive". The wall pass "give and go" followed by a 1v1 is a fundamental midfield to striker combination play. It is very effective in springing the off-side trap with the midfielder receiving a return pass from a striker with back to net and then breaking for goal. Alternatively, a midfielder can be a player further up and striker initiates the passing play.

Avoiding BALLWATCHING is one of the best mental aspects to train players of all ages. Always following through is important. After loss of possession in the attacking third, the transition from attacking to challenging opponents is key in a high pressure fast attack style of play.

FAST BREAK SOCCER GAME TACTICS # 8

4 v 4 On 4 Goals

4v4 play.

Teams score by dribbling balls across line of either goal in opposing end.

Team that gets scored on restarts play from one of their goals.

Two touch passing to set up dribble across goal line

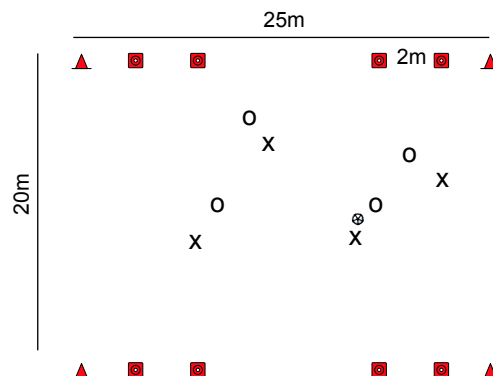

Coaching Points

1. Teams must play with maximum two touches.
2. They must play the final pass to a player who is either open in front of a goal or has at most 1 defender to beat.
3. Teams must attack one goal and then very quickly (one or two passing plays) switch to the other goal. The best way to do this and to keep defenders "honest" is to have all 4 attackers play on one of the goals and then have one quickly sprint away to the other goal to signal a change in point of attack. The other players must recognize the move. They either play a longer pass across, or one of the attackers drops back for a quick supporting pass, receive it, and then play to breaking team mate.
4. After the defending team gains possession, it is critical to transition quickly to attack with fast passing play. Ideally they can get a player breaking fast to one of the goals catching the other team off balance.
5. Obviously, the reverse of (4) is also true. Attacking team must immediately transition to defending after loss of possession. One player must challenge opponent with ball, all others cover and anticipate passes so that they can intercept.

Game Application

The ability to switch point of attack from one side of the field to the other almost always opens up attacking space. The faster the switch, the more likely a fast advance to the opposing goal.

At the same time, breaking fast after gaining possession is the best way to catch a defense off balance.

This drill incorporates both switching sides and fast break, and if done at the same time, starting in the middle third for example, then scoring chances will materialize.

FAST BREAK SOCCER PRACTICE # 9

Warm Up (20 min)

A. Reaction Dribble (4 min)

Players pair up, one ball for each pair.

In one half, player with ball dribbles changing direction and pace frequently. Player without ball follows.

Change roles every 60 seconds

B. Runner's & hamstring stretches

C. Headers

Groups of 3 players.

1. X1 throws ball to head of X2
2. X2 heads to X3 who catches ball.
3. X3 throws to head of X1.

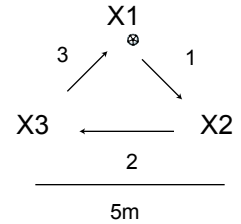

Transition Play (30 min)

4v4 with goalkeepers in field of play is twice the size of penalty box.

Both teams can score into either of the two goals. However, after gaining possession the team with ball must first come back across center of field before attacking either goal.

Change of possession occurs after a goal is scored, the ball goes out of play or the team without ball wins possession during regular play.

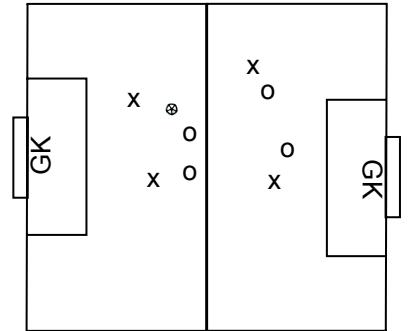

Soccer Speed (10 min)

1. X1 passes to X2 who attacks the ball
2. X2 receives ball and turns with one touch.
3. X2 dribbles to deposit ball with X3,
4. X2 turns and attacks next ball from X1

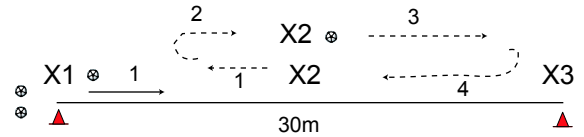

Goal Scoring (20 min)

1. X dribbles along edge of penalty box for a cross
2. As soon as the ball leaves foot of X for cross:
 - one of strikers A attacks ball
 - second striker A runs to far post or gets in supporting position.
 - defender D challenges for ball.

Attacker A with ball can go for one touch shot or header or start 2v1 against D with a quick strike on goal.

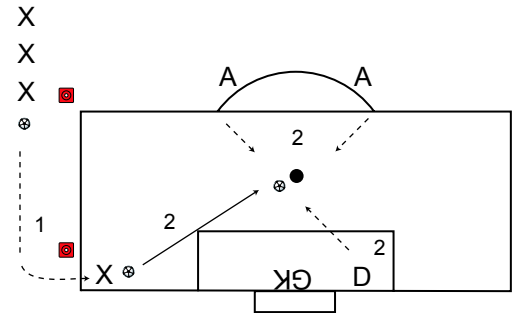

Game Tactics (30 min)

Field is divided into three 25m long sections.

Teams play 4v4 in the center section while 2 players from each team wait in both end sections. Team in possession

1. passes into either of the final (attacking) thirds and
2. sends in a player other than the passer to create a 3v2

X now plays 3v2 to get a shot on goal as fast as possible.

After change of possession play restarts in middle

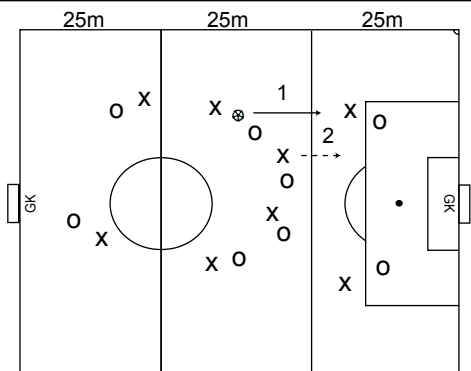

Players should be busy at all times. If drills keep players inactive, break team into smaller groups and run parallel drills.

FAST BREAK SOCCER WARM UP # 9

Reaction Dribble & Headers

A. Reaction Dribble (4 min)

Players pair up, one ball for each pair.

In one half, player with ball dribbles changing direction and pace frequently. Player without ball follows.

Change roles every 60 seconds

B. Runner's & Hamstring Stretches

C. Headers

Groups of 3 players.

1. X1 throws ball to head of X2
2. X2 heads to X3 who catches ball.
3. X3 throws to head of X1.

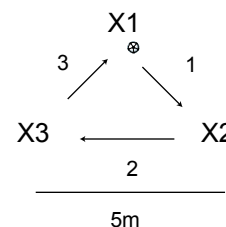

D. Quad & Personal Stretches

Coaching Points

Reaction Dribble:

1. Encourage sudden changes of speed and direction, "the element of surprise".
2. Players with ball should use all change of direction moves they have.
3. Players with ball can add the odd straight dribble to prevent anticipation by follower.

Headers:

1. Throws can vary in height to allow the player heading to stay on feet or require them to jump.
2. It is important to hit the target perfectly with the header.
3. The triangle forces change of direction headers, i.e. requiring head rotation to direct ball at target and striking the ball with the side of the head - so called "glancing" header.
4. This is a warm-up exercise, so stress accuracy over power.
5. Heading warm-ups are effective ways to improve heading confidence for subsequent drills.

Game Application

High paced dribbles with change of direction into space and away from defenders are used to set up a shot or to beat a defender wide and set up for a cross. Defenders need to be able to react quickly to changes of direction to prevent the attacker from being successful. Depending on the angles, the defender needs to react and bring themselves into position for an angled (slide) tackle.

Angled/glancing headers are most frequently used to direct a crossed ball into the corners of the goal. Depending on the angle of the cross relative to the direction of the approaching run, the change of direction required for a successful strike might be quite severe.

FAST BREAK SOCCER TRANSITION PLAY # 9

4 v 4 Attacking Both Goals

4v4 with goalkeepers in field of play is twice the size of penalty box.

Both teams can score into either of the two goals. However, after gaining possession the team with ball must first come back across center of field before attacking either goal.

Change of possession occurs after a goal is scored, the ball goes out of play or the team without ball wins possession during regular play.

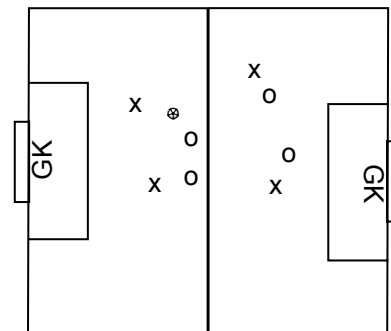

Coaching Points

1. Require maximum of two touches on ball for each player.
2. Players must make diagonal runs into space to receive ball and set up shot or cross.
3. Encourage shooting once players are in attacking half.
4. Players are likely to forget that they have to go back across half after gaining possession - be diligent as coach to enforce this critical rule.
5. Encourage teams to take advantage of a double change of direction, first to cross center and then to immediately cut back and attack the goal they just came from. Teams will tend to cross center and keep going, so keep an eye open for a double change opportunity and stop play to point out opportunities missed.
6. You can vary composition of teams according to your formation, however, it is recommended to have at least one midfielder and one striker in each group of 4.
7. Ask your teams to transition at the highest speeds possible.
8. After loss of possession, players now defending must challenge, cover and mark all attackers as fast as possible.

Game Application

This is a fundamental transition drill. After gaining possession anywhere on the field, teams want to break to generate scoring opportunities as quickly as possible. Catching the opposition before they can set into their defensive shape is very important.

The double change of direction is to train the defending team to react quickly to a sudden change of point of attack. It is a team reaction drill. At the same time it trains the team in possession to vary points of attack and thus become less predictable.

FAST BREAK SOCCER SPEED # 9

Sprint - Receive - Turn - Dribble

1. X1 passes to X2 who attacks the ball
2. X2 receives ball and turns with one touch.
3. X2 dribbles to deposit ball with X3,
4. X2 turns and attacks next ball from X1

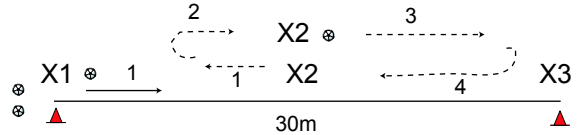

Player X1 starts with 3 balls. After all balls have been deposited with X3, direction changes with X2 now receiving pass from X3 and depositing ball with X1.

After a set of six balls, rotate players. Have each player in the middle three times.

Coaching Points

1. Player must attack ball with a sprint. Pass must be a soft pass and be received within 5m of passer.
2. First touch of player in the middle must set up the dribble in the opposite direction. Ball can be cut back with inside/outside of foot or pulled back with sole. It is important that the ball stays in line between X1 and X3. Ball control cannot be lost and players must ensure that their first touch does not let the ball bounce away.
3. Players turning must rotate on the spot, no looping or wide turns allowed.
4. This drill must look sharp and be timed to perfection - no dead balls, no waiting for ball or players.
5. Demand speed AND accuracy.
6. Extend duration of drill to suit your team's fitness development needs.
7. Players in the middle must tire and you may need to have them play 12 balls in one set depending on age and competitive level.
8. Passers tend to slow down play by reacting to or waiting for run. To keep intensity high passers must lead runners.

Game Application

Players must always approach the ball at high pace to avoid a defender intercepting the pass. The ability to control the direction of the second touch with a precise first touch under pressure and at high pace sets excellent players apart from average players. It is the execution speed of receiving passes, controlling the ball and making the next move that ultimately dictates the speed of the game.

FAST BREAK SOCCER GOAL SCORING # 9

Cross & 2 v 1

1. X dribbles along edge of penalty box for a cross
2. As soon as the ball leaves foot of X for cross:
 - one of strikers A attacks ball
 - second striker A runs to far post or gets in supporting position.
 - defender D challenges for ball.

Attacker A with ball can go for one touch shot or header or start 2v1 against D with a quick strike on goal.

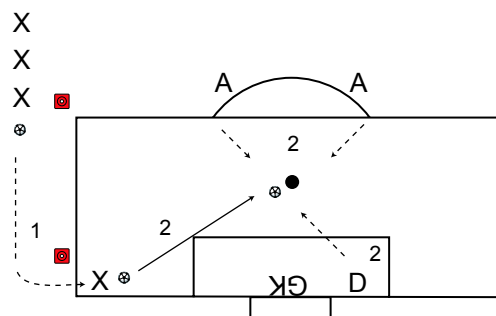

Coaching Points

1. This drill is all about timing of runs !!
2. The cross must be to target area triangle going from the near top corner of the 5m box to the penalty spot to the far top corner of the 5m box.
3. Ensure that the player crossing aligns body with direction of cross. This is best done by playing the last touch of the ball prior to crossing in the direction of the cross.
4. Attackers need to delay their runs until they know where and at what speed the ball is going. One of the attackers decides to go for the ball while the other gets ready to support a 2v1 or get a rebound. If the striker attacking the ball cannot finish on first touch, then they must control the ball and set up a 2v1. Part of this 2v1 may be a flick-on header to the second striker, a touch back to the top of the box, a lateral pass, etc.
5. The defender attacks the ball as soon as they anticipate where the flight of the ball will end.
6. If defender cannot clear on first touch, then they must block a shot by the first striker or react to a pass and then block the second striker.
7. It is vital that the strikers do not over run the crossed in ball, then the ball will end up in their back and an opportunity for goal is missed.
8. Ask for the cross to come from as close to the goal line as possible.

Game Application

This is a drill to develop one of the fundamental soccer attacking plays - the flank attack. Many goals are scored from crosses and the timing of the cross and runs are critical to success. It is also important for the goalkeeper and defender to judge the flight of the ball and the run of the strikers to come out and intercept the cross before the strikers reach the ball.

FAST BREAK SOCCER GAME TACTICS # 9

4 v 4 and 3 v 2

Field is divided into three 25m long sections.

Teams play 4v4 in the center section while 2 players from each team wait in both end sections. Team in possession

1. passes into either of the final (attacking) thirds and
2. sends in a player other than the passer to create a 3v2

X now plays 3v2 to get a shot on goal as fast as possible.

After change of possession play restarts in middle and the team that DID NOT have possession in the last play (o in this example) gets the ball.

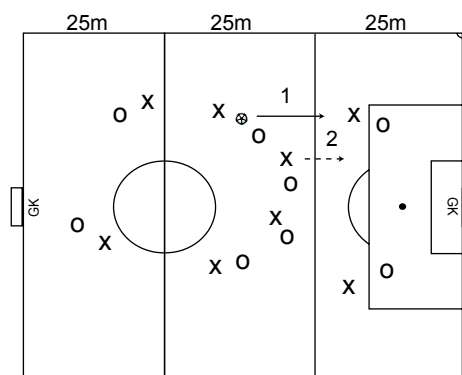

Coaching Points

1. Team with possession in the middle must look for a quick pass into the attacking third.
2. Players in the end zone must be in constant motion relative to play in the middle. They need to get ready to receive a pass or anticipate a quick pass. Creating space and losing the defenders with quick sprints and changes of direction are emphasized.
3. Once a pass is played into an end zone, another player from the team in possession must react quickly and sprint into final third to set up a 3v2. The player closest to the end zone is the most likely candidate. In the example shown, X can also pass to the player running into the end zone.
4. Encourage team in possession to change point of attack suddenly, i.e. if they seem to be attacking the end zone on the right, they should reverse direction and attack end zone on the left. This should put defending team in the middle off-balance. Therefore players in both end zones must be "with" the play mentally and communicate with their team mates in the middle.
5. Ideally you have your midfielders in the middle and one striker and defender for each team in the end zones.
6. This is a good opportunity to train starters vs. substitutes, etc.
7. Once in the attacking zone and playing 3v2, teams must get to a position of taking a shot within seconds - requiring quick one or two touch passing, diagonal runs, through passes, etc.

Game Application

Developing plays in midfield with quick passes into the attacking third sets up scoring chances. Isolating a certain area of the field to set up odd man advantages (3v2, 2v1, 4v3) will allow your team to keep moving the ball forward quickly. Pass and follow plays have the ability to set up a series of odd man advantage situations. So even though your team in total might be outnumbered 3 to 6 for example, your 3 attackers can create 3v2 situations through clever running and passing.

Fast break soccer demands midfielders to commit to join the attack on a regular basis. In order to vary the attack and spread the physical demands amongst players, teams need to vary which midfielder joins the attack. This drill is an excellent way to develop this variability while ensuring your team's defensive shape and balance is maintained.

FAST BREAK SOCCER PRACTICE # 10

Warm Up (20 min)

A. Pursuit Dribble

1. Players in 4 groups around center circle
2. Each player numbered 1-4, with a ball
3. Coach calls out a number from 1-4
4. Players with that number dribble around circle. Player getting back to their group first wins.
5. Players waiting tap ball between feet.

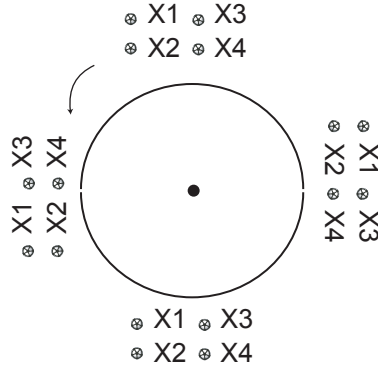

B. Runner's & hamstring stretches

C. Pursuit Dribble Reverse

Same as A, dribble in opposite direction

D. Quad and personal stretches

Transition Play (30 min)

1. X plays 1v1 against O
2. Target players (T) in each of four goals in corner
3. X defends goals behind X, and O defends goals behind O
4. Player in possession (X shown) scores a point by passing to one of the two target players in the goals being attacked
5. After successful pass, passer (say X) takes position in of target player (T) passed to.
6. Target player receiving ball now breaks out and attacks opposite goals, which are defended by remaining player in field (say O).

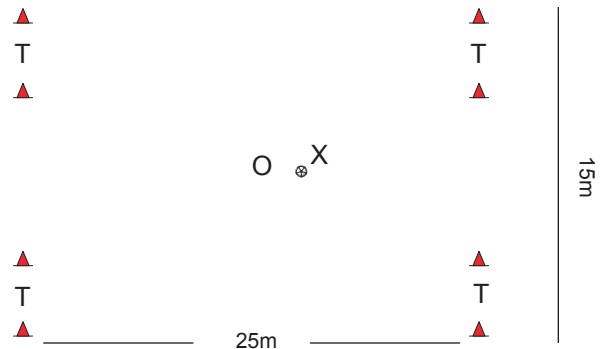

Soccer Speed (10 min)

1. Goalkeeper plays ball out
2. X and O sprint around cones, each trying to gain possession of ball.
3. Player getting to ball first attacks goal, other player defends.

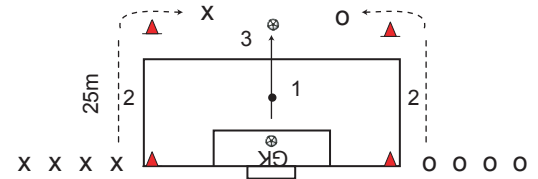

Goal Scoring (20 min)

1. M1 passes ball to M2. At the same time, attacker A runs away from goal. Defender D follows attacker. A should position body such that A can see M2 and goal, making A's run an angled backwards side step run. D has to stay close to A and inside.
2. A chooses a moment to turn and sprint towards goal, leaving D behind. At that moment, M2 passes into run of A.
3. A now takes a shot on goal.

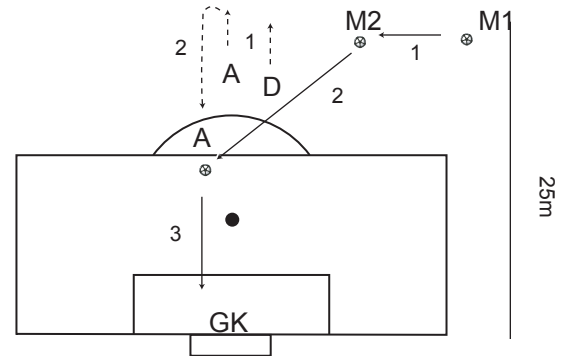

Game Tactics (30 min)

1. A1 passes to A2 (shown) or A3 who
2. receives ball and turns with first touch and passes ball with second touch into run of A4 (shown) or A5
3. A4/A5 have a free dribble on outside of cones.
4. A4/A5 cross to A6/A7

Defenders (D) try to win ball and play it back to A1. Outside defenders can try to block cross but cannot tackle A4/A5.

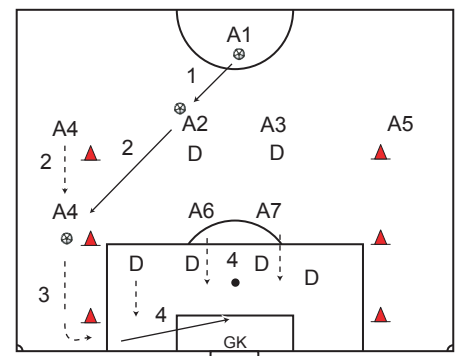

Players should be busy at all times. If drills keep players inactive, break team into smaller groups and run parallel drills.

FAST BREAK SOCCER WARM UP # 10

Pursuit Dribble

A. Pursuit Dribble

1. Players in 4 groups around center circle
2. Each player numbered 1-4, with a ball
3. Coach calls out a number from 1-4
4. Players with that number dribble around circle. Player getting back to their group first wins.
5. Players waiting tap ball between feet.

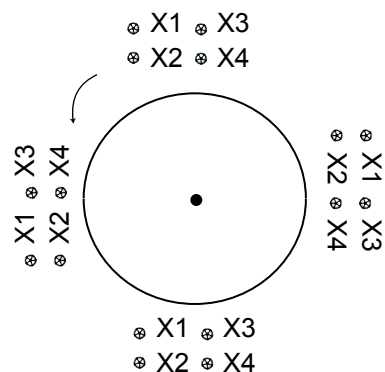

B. Runner's & Hamstring Stretches

C. Pursuit Dribble Reverse

Same as A, dribble in opposite direction

D. Quad and Personal Stretches

Coaching Points

1. Players run around the outside of players waiting, therefore keep players waiting close to circle. Otherwise they may obstruct the dribblers and "cheat".
2. Players dribbling must keep close control of ball.
3. Players waiting must look at players running and at the same time move ball between their feet. They need to "stay on their toes" while tapping ball back and forth and therefore be ready for "their run".
4. Coach can add challenge by sending the next group running before the previous one has returned to their group.

Game Application

This drill fosters reaction to an outside stimulus, a call from a team mate for example. Players in a game must always be aware of their surroundings and make a decision to change their action. In this case players progress from holding/shielding the ball and then starting a fast dribble into space.

Dribbling with use of both feet while keeping tight control at high pace is a skill that makes any player less predictable.

The change of pace and direction is a standard method of losing defenders.

FAST BREAK SOCCER TRANSITION PLAY # 10

1 v 1 On Two Goals

1. X plays 1v1 against O
2. Target players (T) in each of four goals in corner
3. X defends goals behind X, and O defends goals behind O
4. Player in possession (X shown) scores a point by passing to one of the two target players in the goals being attacked
5. After successful pass, defender (say O) takes position of target player (T) passed to.
6. Target player receiving ball now breaks out and attacks opposite goals, which are defended by remaining player in field (say X).

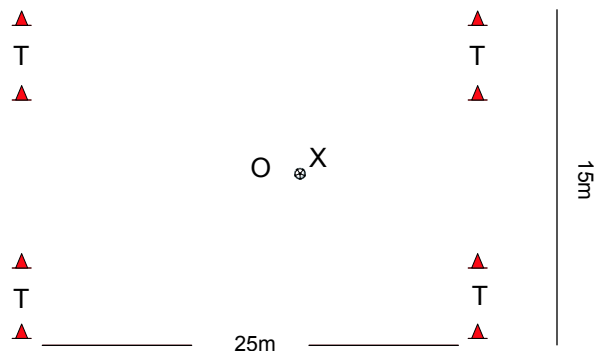

Coaching Points

1. Player in possession can play long passes to target player or try to beat defender and come closer to T for a more accurate pass.
2. If ball goes out of bounds, defending player gets possession and dribbles in from sideline.
3. Target player who receives ball must dribble out of goal fast to catch defender in field "off-balance".
4. Attacker must transition quickly to now defend again.
5. Set up 2 or 3 fields depending on number of players.
6. Suggestion is to use 2 defenders, 2 midfielders and 2 strikers in each grid.

Progression Option: Play 2v2 in middle.

Game Application

1v1 situations are key attacking situations in which a striker tries to beat a defender for a shot, or a wide player wants to dribble past a defender to get in position for a cross.

A pass to a target player over a 5-15 m distance are part of modern short passing soccer.

The transition in this drill is for the player who was attacking and made a pass. This occurs in games when a pass was intercepted, or the team mate lost the ball. The opponent breaks out quickly and now the attacker must defend. Target players (T) transition to a fast break attack having gained possession.

FAST BREAK SOCCER SPEED # 10

Sprint and 1 v 1

1. Goalkeeper plays ball out
2. X and O sprint around cones, each trying to gain possession of ball.
3. Player getting to ball first attacks goal, other player defends.

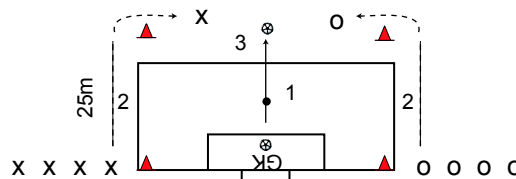

Coaching Points

1. Goalkeeper must vary distance and direction of passes out. Direction change will favour one player and distance change will increase the length of the sprint.
2. The player who decides that they will not get to ball first must immediately get into position to defend the goal.
3. Encourage players to take a quick shot after winning ball. You do not want an extended 1v1 battle, but rather have players get to a fast shot.
4. Defender can win ball and take a quick shot.
5. It is important to keep drill moving so that rest periods for players are not too long.

Game Application

Short sprints to win the ball are the one of the elemental soccer fitness requirements.

Beating a defender to the ball and getting the body between ball and defender to shield ball and increase chance of successfully controlling ball is an important skill and strength requirement.

Getting to a quick shot anywhere near the penalty box is a potent offensive weapon, but many players try to work the ball closer to goal or to "set it up" perfectly. This delay often results in losing the opportunity.

Correctly judging that you are losing the sprint and then getting to proper defensive positioning is an important mental skill helping your team getting into defensive shape quickly.

FAST BREAK SOCCER GOAL SCORING # 10

Combination Passing & Shooting

1. M1 passes ball to M2. At the same time, attacker A runs away from goal. Defender D follows attacker. A should position body such that A can see M2 and goal, making A's run an angled backwards side step run. D has to stay close to A and inside.
2. A chooses a moment to turn and sprint towards goal, leaving D behind. At that moment, M2 passes into run of A.
3. A now takes a shot on goal.

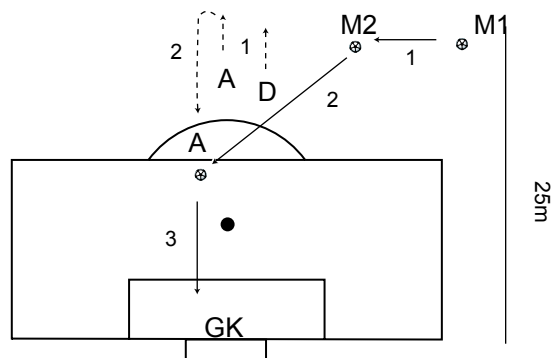

Coaching Points

1. This drill must flow smoothly without players waiting.
2. Pass from M1 to M2 must happen while A and D are running.
3. A can take the pass from M1 as a cue to change direction and sprint.
4. M2 should be able to receive the ball and turn on the first touch, pass on the second touch, without waiting for A.
5. A must be able to sprint into pass from M2 without ball stopping or A having to stop and wait for ball.
6. Emphasize to players that they need to focus on cues, signals, timing and react to plays.
7. M1 and M2 should be midfielders, A is a striker and D a defender. Change positions and roles based on your system of play.
8. D must stay inside and within arm's length of A, no cheating!
9. A needs to sprint a significant distance before turning to create enough space behind them and make M2's pass easier.

Progression option: Put a first passive, then active defender on M2.

Game Application

This is a combination play often used to create space. Midfielders combine with quick passes, strikers "check in and out" to get away from defenders.

Accuracy of passing and proper timing will unlock defenses and create space for either a shot on goal or, if the play is along a side line, for a cross.

FAST BREAK SOCCER GAME TACTICS # 10

Combination Play & Flank Attack

1. A1 passes to A2 (shown) or A3 who
2. receives ball and turns with first touch and passes ball with second touch into run of A4 (shown) or A5
3. A4/A5 have a free dribble on outside of cones.
4. A4/A5 cross to A6/A7

Defenders (D) try to win ball and play it back to A1. Outside defenders can try to block cross but cannot tackle A4/A5.

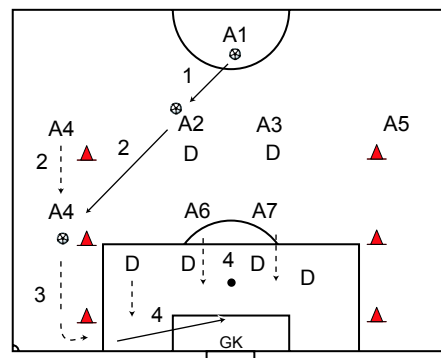

Coaching Points

1. Combination must flow smoothly without players waiting.
2. Initially, ask defenders covering A2/A3 to be passive to allow A2/A3 to execute receipt/turn/pass sequence with perfection. Once this sequence flows, defenders can increase pressure.
3. A6/A7 must time their runs to meet the cross with power. Often strikers run to soon and then wait for ball. Ensure that the runs are to near and far posts.
4. A1 likely is a defender, A2-A5 are midfielders and A6/A7 strikers in a 4-4-2 system. Adjust the players according to your system of play.
5. Defenders are shown in a classic 4-4-2 system as well, please adjust to your system and your opponent's system of play.
6. Crosses should be to target areas.

Variation option: Have A1 make an overlapping wide run and have A4/A5 drop back to take A1's spot.

This drill is very useful in practicing your attacking formation against various defensive formations and to train your defensive set up against various attacking schemes.

You may discover new styles of playing for your team and your players will learn how to adjust on the field based on what they see from opponents.

Game Application

Modern soccer has a fairly even mix between attacking down the flanks and through the middle. Setting up quick and accurate passes through the midfield to wide players is critical. The wide players could be overlapping midfielders or defenders, or strikers who have gone wide. It is important to vary the attack. What remains constant is the run, the position from which the ball is crossed and the runs to near and far post.

FAST BREAK SOCCER PRACTICE # 11

Warm Up (20 min)

A. Reaction Passing

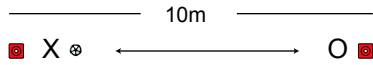

X and O pass ball to each other
 O uses left or right foot, one or two touches
 X uses same foot/# touches as O
 Reverse roles every 2 minutes

B. Runner's & hamstring stretches

C. Sequence Passing

5-7 (6 shown) players in a grid, each player gets a number from 1 to 6

Players pass in sequence of numbers
 1. X1 passes to X2.
 2. X1 then moves into space away from next pass
 Players without ball move constantly

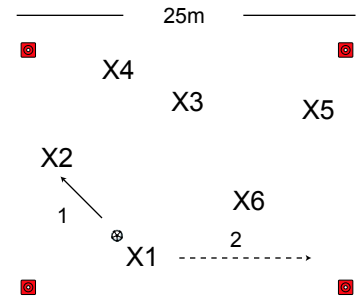

D. Quad and personal stretches

Transition Play (30 min)

Two teams of 8 play on 1/2 field divided into 3 equal zones

Team in possession must have all players in middle zone before they can score. In the example shown, the last X in own third must move up. If O where to gain possession in middle zone, the two O's in their defending zone must fast break to middle zone.

In defending and middle zone, play is two touch.

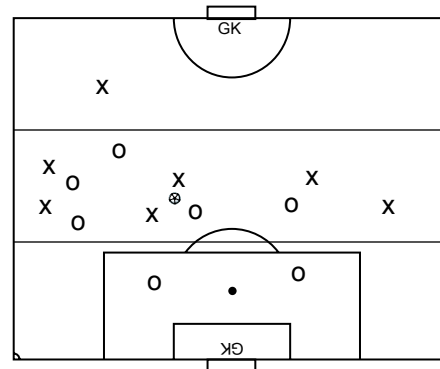

Soccer Speed (10 min)

1. X passes to O and follows pass sprinting around O.
2. O lays ball across with one touch into run of X.
3. X passes with one touch to next X in line and sprints to back of line.

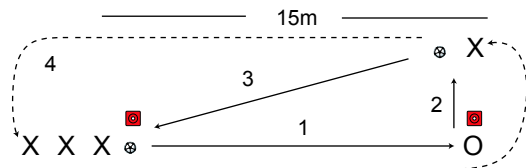

Goal Scoring (30 min)

1. O passes ball to X who attacks ball, receives it and turns with one touch.
2. X dribbles around cones.
3. X passes through a small goal, jumps over an imaginary goal line (use hurdles if you can).
4. X takes a one touch shot on goal.

Once the first X starts around first cone, the second X passes to first O to keep two lines moving.
 After shot, X goes to end of line O and O to line X

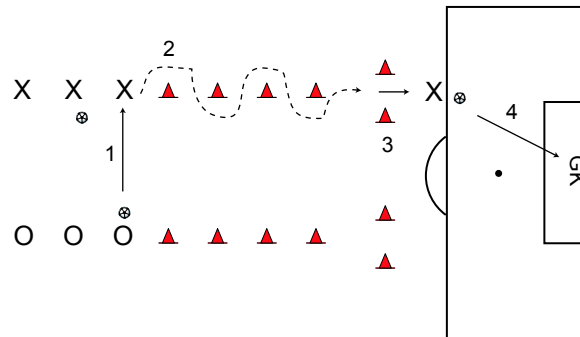

Game Tactics (30 min)

Two teams of 8 using full field.
 Teams must play ball to a team mate in one of the four squares in the corners of the field (example shows passes 1,2 and run 3 by team O).
 Once in square, player cannot be challenged and plays a cross into penalty box for a shot/header on goal.
 Both teams can score into either goal, however, after a goal is scored, the ball must first be played across center into the other half of field by the goalkeeper.

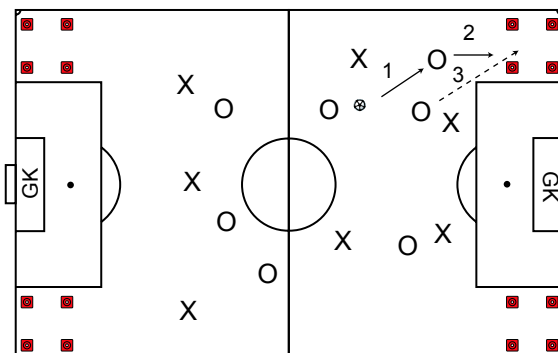

Players should be busy at all times. If drills keep players inactive, break team into smaller groups and run parallel drills.

FAST BREAK SOCCER WARM UP # 11

Reaction & Sequence Passing

A. Reaction Passing

_____ 10m _____

■ X ⊕ ←————→ O ■

X and O pass ball to each other
O uses left or right foot, one or two touches
X uses same foot/# touches as O
Reverse roles every 2 minutes

C. Sequence Passing

5-7 (6 shown) players in a grid,
each player gets a number from 1 to 6

Players pass in sequence of numbers
1. X1 passes to X2.
2. X1 then moves into space away
from next pass
Players without ball move constantly

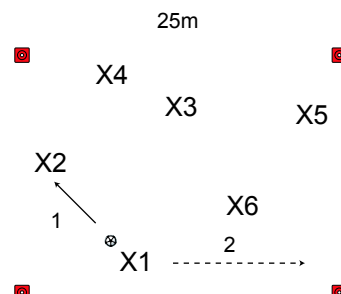

B. Runner's & Hamstring Stretches

D. Quad and Personal Stretches

Coaching Points

Reaction Passing:

1. After players pass, they must remain in motion "on balls of feet" to be ready to move/receive pass
- no waiting flat footed -
2. Keep passes on ground and at proper weight for the distance allowing for easy control
3. Challenge players to be 100% accurate in repeating partner's last play.

Sequence Passing:

1. Players must move freely in grid, never stand around waiting for pass.
2. The next pass must have an unobstructed line to the receiver - the result of proper anticipation and movement.
3. Players need to look up and be aware of who receives pass next - ask them to communicate
4. Encourage two touch play.
5. Do not allow them to simply pass in a circle as they run around.

Game Application

Developing the vision of what happens around you during a game, while being in possession of the ball is challenging. However, it is vital for perception and speed of decision making. Play will become faster.

In the sequence passing drill we train vision of the field, awareness of team mates and quick movement, all elements of high quality soccer. Passing and then moving into space to either drag away opponents or to get open for a return pass is an essential element of effective soccer.

FAST BREAK SOCCER TRANSITION PLAY # 11

8 v 8 with Defenders Breaking Fast

Two teams of 8 play on 1/2 field divided into 3 equal zones

Team in possession must have all players in middle zone before they can score.

In the example shown, the last X in own third must move up.

If O where to gain possession in middle zone, the two O's in their defending zone must fast break to middle zone.

In defending and middle zone, play is two touch.

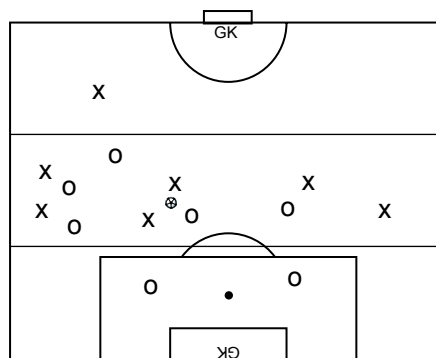

Coaching Points

1. Encourage players to communicate ensuring that defenders move out quickly.
2. Defenders need to sprint to middle third to avoid slowing down attack on goal.
3. Foster quick play through middle zone and first time shots once inside penalty box.
4. Make up the teams based on your system of play, i.e. if you play a 4-4-2, then have two strikers, three midfielders and two defenders on each team.
5. You can modify the line up of the teams to isolate and train specific functional units. For example, play one team with 1 defender, 4 midfielders and 2 strikers to play a normal 4-4-2 attack. Play the other team with 4 defenders, 2 midfielders and 1 striker to play the normal 4-4-2 defense. This will force the 4 midfielders on the first team to track back and the outside defenders on the second team to attack down the flanks. You need to plan the starting line-ups and any progression very carefully before practice starts.

Game Application

The key here is to get defenders to play the ball out of the defending zone as quickly as possible and to move up field to join the play. This is a building block of fast break soccer. This also compresses the field and once defenders get past center, allows the set up of the off-side trap if the opponents counter attack. Playing through the middle third quickly follows the key principle of not allowing opponents to settle into their defensive shape. The more off-balance the defence, the more likely good scoring plays will develop.

FAST BREAK SOCCER SPEED # 11

Pass - Sprint - Overlap

1. X passes to O and follows pass sprinting around O.
2. O lays ball across with one touch into run of X.
3. X passes with one touch to next X in line and sprints to back of line.

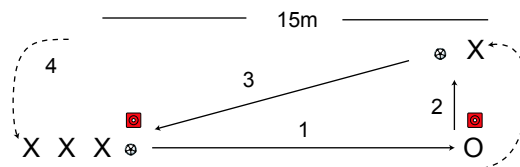

Coaching Points

1. Passes must be to feet at proper pace to keep the play flowing and allow for successful receiving by players.
2. O must lay off ball "square" or slightly ahead diagonal to overlapping X keeping it within 2m of O to avoid X having to run wider than necessary to get to ball.
3. X turns around O as tightly as possible, but always within 2m of O.
4. X must play a properly weighted pass to next X in line such that the next player can play a one touch (or at most a two touch) pass to O.
5. X always sprints after the pass is made.

Game Application

Overlapping runs by defenders or midfielders are the essence of today's wide attacking game.

Passing and moving immediately after the pass will make play less predictable for the opponents.

Accurate and properly weighted passes are the key ingredient to set up fast breaks. Sprinting into space against defenders who are facing the play is the best way to "lose" a defender, because they have to turn first before they can "chase".

FAST BREAK SOCCER GOAL SCORING # 11

Receive Pass - Turn - Dribble - Pass - Shoot

1. O passes ball to X who attacks ball, receives it and turns with one touch.
2. X dribbles around cones.
3. X passes through a small goal, jumps over an imaginary goal line (use hurdles if you can).
4. X takes a one touch shot on goal.

Once the first X starts around first cone, the second X passes to first O to keep two lines moving.

After shot, X goes to end of line O and O to line X

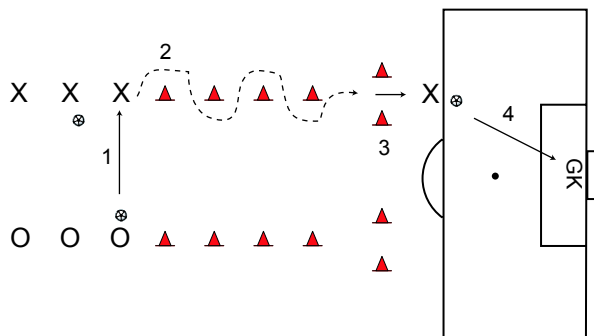

Coaching Points

1. Pay attention that the player receiving the pass uses one touch to change direction and then dribbles around the outside of the first cone.
2. Vary the pass to add levels of difficulty, starting with easy ball on the ground, then a harder pass and finally a chip pass.
3. Encourage players to be ready and not stand and "ball watch"
4. The pass through the small goal or under the hurdle must be waited such that after the jump the passer collects a ball that is still moving.
5. After collecting their own pass, players must shoot directly or at most use one more touch to set up a shot.
6. Players should look at their target (goal) while jumping over hurdle, leaving them only to focus on the final strike of the ball.
7. Some players will shuffle their feet after the jump to strike the ball with their favourite foot. Encourage them to strike fast regardless of which foot they use.

Game Application

The one touch and turn receiving of the ball and then going around the outside of the cone trains the game situation in which players want to drag the ball away from marking defenders into space on the first touch. Creating that space to set up dribbles or subsequent passes is a critical soccer skill.

The jump replicates playing a pass by a defender who then slide tackles and misses the ball. Jumping over the defenders legs keeps the attack flowing and is better than going down for a free kick.

Taking quick shots once inside the penalty box increases chance of success.

FAST BREAK SOCCER GAME TACTICS # 11

8 v8 On Two Goals With Flank Attack

Two teams of 8 using full field.

Teams must play ball to a team mate in one of the four squares in the corners of the field (example shows passes 1,2 and run 3 by team O).

Once in square, player cannot be challenged and plays a cross into penalty box for a shot/header on goal.

Both teams can score into either goal, however, after a goal is scored, the ball must first be played across center into the other half of field by the goalkeeper.

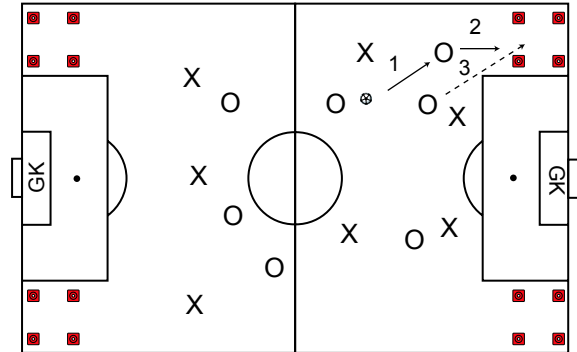

Coaching Points

1. Players will have a tendency to follow attackers into square, keep reminding that they cannot.
2. Play two touch soccer to keep the pace of play high.
3. Teams also tend to decide to play ball into one of the squares and then stick with that strategy. This will result in a cluster of players from both teams around that square. If you see this happen, stop play and point out the wide open spaces on the field which present an opportunity for changing the direction of play and breaking quickly to attack the open space and goal.
4. Players may forget that they only have to cross back over center after a goal is scored - remind them.
5. Regular soccer rules apply for re-starts.
6. Make up the teams according to your regular line up.
7. Reduce size of field depending on skill, fitness level, age and number of players available.

Progression Option: Allow defenders to follow into square.

Game Application

Attacking down the sides followed by effective crosses accounts for about 1/3 of goals scored in soccer.

This drill trains your team to change the point of attack by encouraging playing the ball out of traffic into another square. This will utilize available space and the faster the switch is made, the more likely your opponent will be caught out of position.

By completely changing direction and attacking a square in the other half you are training classic counter attacking.

FAST BREAK SOCCER PRACTICE # 12

Warm Up (20 min)

A. Change Of Direction Dribble

Set up 15-20 small (2m wide) goals with cones. Use no more than half the field.

Each player dribbles through each goal, accelerating out of goal with a change of direction move.

C. Pass - Sprint - Cut Back - Pass

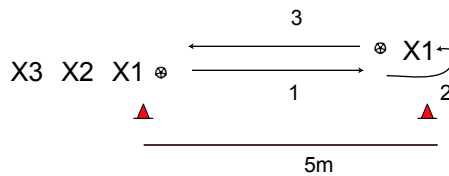

1. X1 passes ball 5m out and sprints after it
2. X1 cuts ball back with inside of foot
3. X1 passes back to X2 with second touch
4. X2 passes out with 1st touch, X1 sprints behind X3

B. Runner's & hamstring stretches

D. Quad and personal stretches

Transition Play (20 min)

Split team into two even groups and play in a 30m x 30m grid.

One player from each team holds a 2m long stick (flag pole, broom) shoulder high between them and move freely within grid.

The two teams play to score from either side into moving goal. Players making up goal try to avoid being scored on.

Change players making up moving goal every 4 minutes.

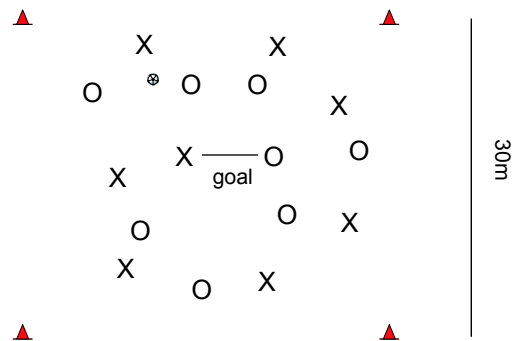

Soccer Speed (12 min)

1. A passes ball to B, who attacks to receive it
 2. B one touch passes back to A and
 3. Turns and sprints to receive pass from C
- Change player in middle every 2 minutes

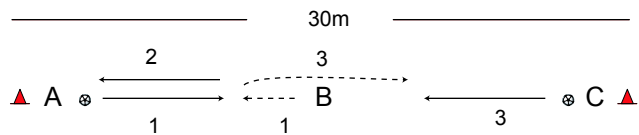

Goal Scoring (25 min)

1. GK rolls/throws ball towards attacker (A) and defender (D) at opposite goal.
2. A sprints to ball followed by D.
3. A gets to ball first and with first touch plays it away from D to create space. A turns while D sets up in defensive position. A now plays 1v1 against D on goal.

After attempt on goal, play restarts attacking opposite goal.

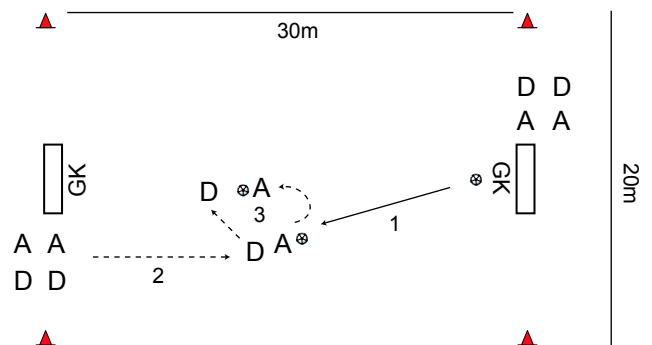

Game Tactics (30 min)

Two teams play on half field.

Team in possession must pass or dribble through one of the 2m wide goals along the sides before they can cross ball in or play it into middle for shot on goal.

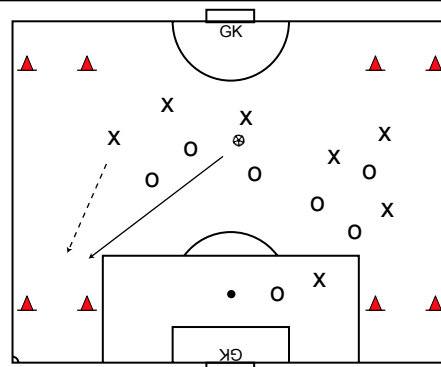

Players should be busy at all times. If drills keep players inactive, break team into smaller groups and run parallel drills.

FAST BREAK SOCCER WARM UP # 12

Dribble & Pass with Change of Direction

A. Change Of Direction Dribble

Set up 15-20 small (2m wide) goals with cones.

Use no more than half the field.

Each player dribbles through each goal, accelerating out of goal with a change of direction move.

B. Runner's & Hamstring Stretches

C. Pass - Sprint - Cut Back - Pass

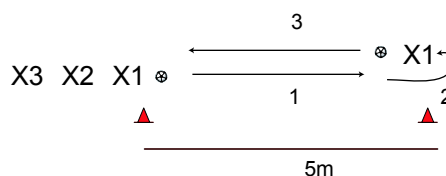

1. X1 passes ball 5m out and sprints after it
2. X1 cuts ball back with inside of foot
3. X1 passes back to X2 with second touch
4. X2 passes out with 1st touch, X1 sprints behind X3

D. Quad and Personal Stretches

Coaching Points

Change Of Direction Dribble:

1. Players must dribble with heads up to see field and choose an open goal to dribble through.
2. Players must dribble at average pace through goal, then accelerate into a new direction of dribble before slowing pace again.
3. Ask players to use different moves to change directions, such as inside foot turns, outside foot turns, step over, etc.

Pass - Sprint - Cut Back - Pass:

1. Players must pass straight out and weight the pass such that it almost stops at the target distance of 5m.
2. Players sprint to cut back a slightly moving ball. Cut back must be 180 degrees so that player faces the next player in line in a straight line for the return pass.
3. Vary cut back moves (inside foot, outside foot, pull back with sole of foot, etc).
4. Emphasize accuracy over speed of pass.
5. If one touch passing reduces accuracy, allow two touches until accuracy improves.

Game Application

Dribbling at defenders and beating them with a change of direction move is a key skill for all players, but in particular for strikers and wide (wing) players. The second drill emphasizes the same skill by sprinting to a 50/50 ball in a game and immediately controlling ball away from opponent with first touch. This also allows shielding of the ball. After controlling ball into space, a quick pass with second touch continues the fast pace of play, thus catching opponents off-balance. This trains vision as players need to be aware of space around them to choose area to dribble into or players to pass to while maintaining control of the ball.

FAST BREAK SOCCER TRANSITION PLAY # 12

7 v 7 On Movable Goal

Split team into two even groups and play in a 30m x 30m grid.

One player from each team holds a 2m long stick (flag pole, broom) shoulder high between them and move freely within grid.

The two teams play to score from either side into moving goal.

Players making up goal try to avoid being scored on.

Change players making up movable goal every 4 minutes.

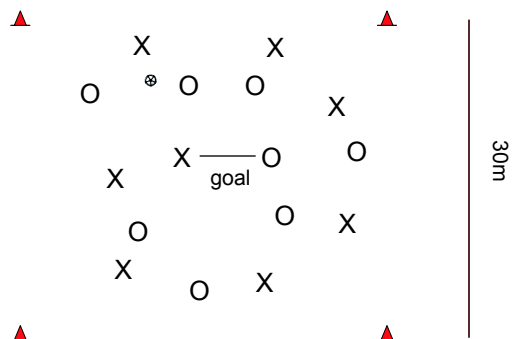

Coaching Points

1. Encourage two touch play
2. Shots on goal must be direct, with first touch.
3. Teams will tend to keep attacking the goal from the side they are on at the moment, leading to all players being on the same side of the goal and bunching up near the goal. This will leave lots of space easily visible by the coach. If that happens, stop play and point out the spaces. Encourage them to switch point of attack with longer passes or a few quick passes to set up a clearer shot from the other side of the goal. To do this, players from the attacking team must make runs to the opposite side into a position that allows a successful pass.
4. You may want at least one player from the attacking team to permanently stay on the opposite side of play as a target player.
5. Player with ball and team mates must not only see the moving goal but also anticipate where it is moving to so they can set up quick passes leading to shots on goal.
6. After change of possession, the team gaining the ball must transition as fast as possible (mentally and physically) to attacking the target.
7. Teams may tend to focus on winning and keeping possession of the ball so much that they forget that the objective is to score on the goal. If this happens, stop play briefly to make the point and restart.

The movement of the players holding the stick can tell a lot about their decision making speed, communication, co-ordination, perception and anticipation.

Game Application

Soccer games are dynamic with both teams in constant motion, therefore players must develop vision to see space and then use it. They must also anticipate motion to be able to change the point of attack to exploit "future" space and catch the opponent off-balance. Two touch play keeps the game pace at a high level and direct shots, when available, can lead to more goals being scored.

Supporting runs into space to receive a pass are key tactical movements. Players who make the run need to communicate verbally to let player in possession know.

Teams gaining possession must break out fast before the opposing team has a chance to set up into their defensive shape.

FAST BREAK SOCCER SPEED # 12

Receive - Pass - Turn - Sprint - Receive

1. A passes ball to B, who attacks ball to receive it
2. B one touch passes back to A and
3. Turns and sprints to receive pass from C

Change player in middle every 2 minutes

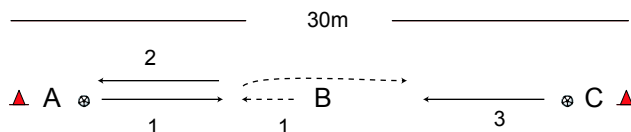

Coaching Points

1. Ball to player in the middle must be a distance of 10m maximum, thus requiring a 5m sprint to first pass and 10m sprints for all subsequent passes.
2. The pass to the middle must be straight out and on the ground for easy control. The weight of the pass must be such that the ball is barely moving at the 10m distance.
3. Player in middle must slow down slightly before reaching the ball to allow for a controlled first touch pass back, on the ground, with perfect accuracy to the target player. Player needs to look up at target just prior to passing. This will be more difficult towards the end of the 2 minute interval.
4. Players at the ends must be ready to receive pass, i.e. not be flat footed but stay on balls of feet. Should the ball from middle player be erratic, end players must recover the ball quickly to be in position in time for the next pass.

Game Application

Soccer is a game of constant motion with occasional sprints. Players must be fit and ready to sprint to ball at any time in game. Therefore speed training is vital.

The ability to control the ball, weight passes properly, and hit a target player with accuracy after a sprint is a vital technical skill.

This drill will stress the player in the middle and lead to fatigue at the end of the 2 minute interval. This replicates a late game situation where all energy and mental strength must be employed for that one final run, that one final accurate pass.

FAST BREAK SOCCER GOAL SCORING # 12

Sprint To Pass - Turn - 1v1 - Shoot

1. GK rolls/throws ball towards attacker (A) and defender (D) at opposite goal.
2. A sprints to ball followed by D.
3. A gets to ball first and with first touch plays it away from D to create space. A turns while D sets up in defensive position. A now plays 1v1 against D on goal.

After attempt on goal, play restarts attacking opposite goal.

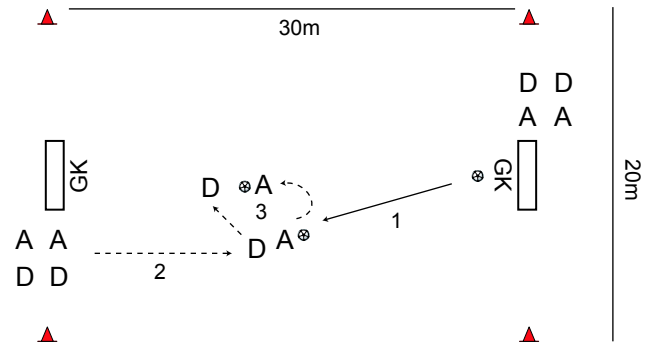

Coaching Points

1. The play from the goalkeeper should vary and must be at a pace requiring attacker and defender to sprint at least 15m before they can reach it.
2. Ask defender to allow attacker to reach the ball first, try to match up your pairs based on speed.
3. Encourage quick play, if players get bogged down in the 1v1 then stop play and get next group going.
4. Ball going out of bounds stops play and next group goes.
5. Have a supply of balls at each goal so that goalkeepers can restart play immediately.
6. Ask attacker to shoot as soon as they see some space past defenders, do not try to set up the perfect shot every time.

Game Application

Quite frequently, if not most times, strikers will be with their back to the goal they are attacking with a defender marking them from behind. It is therefore a vital skill for strikers to be able to release quickly from the defender to win a ball, turn as quickly as possible with the ball and beat the defender with excellent 1v1 moves.

Seeing small gaps through defenders and striking the ball through those gaps makes it very difficult for the goalkeeper to see the ball and react to it, thus increasing probability of scoring a goal.

FAST BREAK SOCCER GAME TACTICS # 12

7 v 7 Flank Attack

Two teams play on half field.

Team in possession must pass or dribble through one of the 2m wide goals along the sides before they can cross ball in or play it into middle for shot on goal.

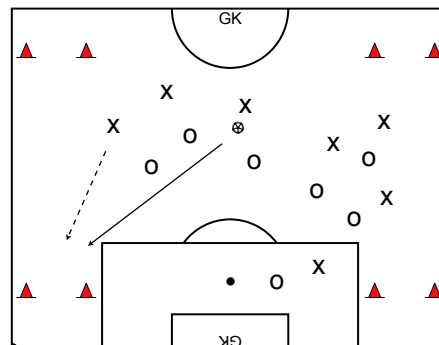

Coaching Points

1. Small goals along sides are 2 m wide.
2. Encourage players to switch play to the opposite side to exploit available space.
3. Ask players to decide whether to dribble through a goal or to pass to a player running into the space in front of it.
4. Players must support each other with runs into space.
5. If the defending team wins possession, it must break fast towards one of the wide goals. Therefore ask players to make immediate fast runs breaking towards wide goals. This requires the first decision of the transitioning team: Do we play vertical ahead, switch to opposite side, or play short passes out?
6. Make up teams according to your system of play and vary the line-ups:
 - play midfield plus strikers against defenders and defensive midfielders (5M+2S v. 4D+3M)
 - place defenders, midfielders and strikers on each team (eg. 4-4-2: 1D+4M+2S v 4D+2M+1S)
 - consider playing starters vs substitutes
7. Plan the line-ups of these teams in advance, the variations and the times allotted to each line-up.

Game Application

Teams either attack along the flanks to set up a cross or they attack through the middle. It is most effective to play the crosses into the space between defenders and goalkeepers.

Switching play quickly will unsettle defenses and increase opportunities to get quality crosses in.

Recognizing space, making runs into it and playing the ball to arrive at the same time as the runner is a critical combination of mental, technical and physical skills.

FAST BREAK SOCCER PRACTICE # 13

Warm Up (20 min)

A. Agility Dribble

Each player has a ball and dribbles freely. Players change direction of dribble using 1v1 change of direction moves. Players top ball alternating between sitting on it and putting one knee on it.

B. Runner's & hamstring stretches

C. Pass & Sprint Follow

Two players at one cone, one player at each of the other cones. Players pass ball to any other player and sprint to that cone. Player receiving ball passes with second touch and follows.

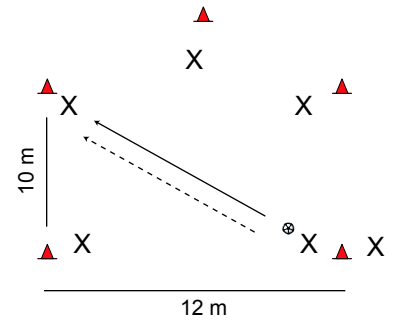

Transition Play (20 min)

3 teams of three, each team identified with different colour pinnies (practice vests).

Two attacking teams (example A and B) play against a third defending team (C).

As soon as defending team (C) wins ball, C now becomes an attacking team and the attacking team that last touched ball prior to loss of possession becomes the defending team.

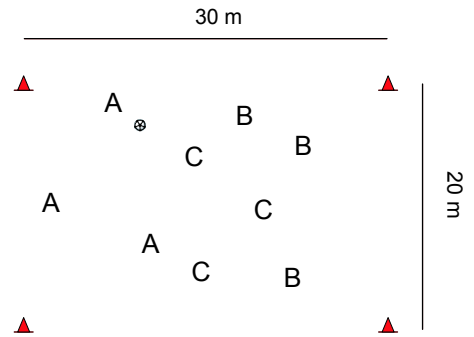

Soccer Speed (10 min)

1. X passes diagonal into run of O.
 2. X sprints down line.
 3. X receives return pass from O.
 4. O sprints down the line.
 5. O receives return pass from X.
- Players keep going back and forth using one touch passing

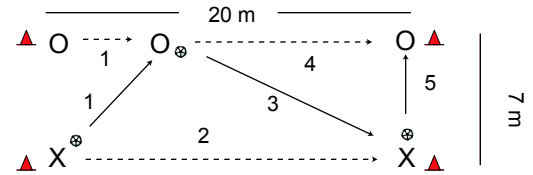

Goal Scoring (30 min)

1. Two players, 5m apart, pass ball back and forth to each other.
2. At random, player facing goal passes to either left or right side.
3. One of X and O (X shown) sprints to ball while the other player sprints goal side to defend.
4. X and O now play 1v1 on goal.

Change players passing every five minutes.

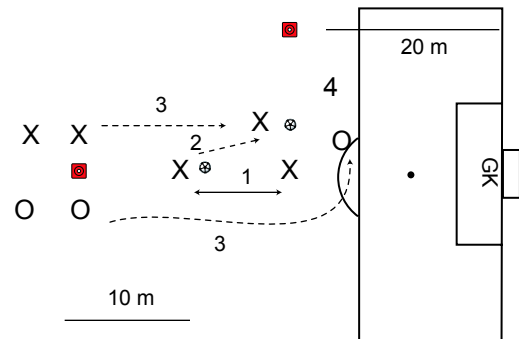

Game Tactics (30 min)

A in center circle plays a long ball to either A in a grid just outside the penalty box.

Once wide player A receives ball, defenders (D) can challenge.

A now play 5 v 4 against D.

Once D gains possession or clears ball, play restarts.

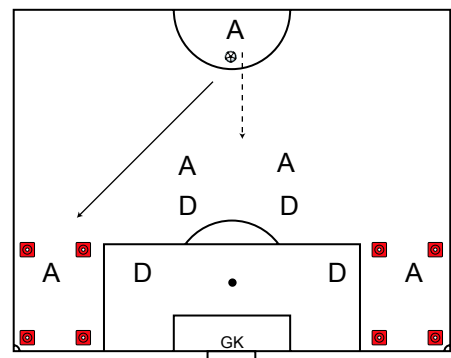

Players should be busy at all times. If drills keep players inactive, break team into smaller groups and run parallel drills.
Copyright 2008 by Sauder Consulting Inc.

FAST BREAK SOCCER WARM UP # 13

Agility Dribble, Pass & Sprint Follow

A. Agility Dribble

Each player has a ball and dribbles freely. Players change direction of dribble using 1v1 change of direction moves.

Players stop ball alternating between sitting on it and putting one knee on it.

C. Pass & Sprint Follow

Two players at one cone, one player at each of the other cones.

Players pass ball to any other player and sprint to that cone. Player receiving ball passes with second touch and follows.

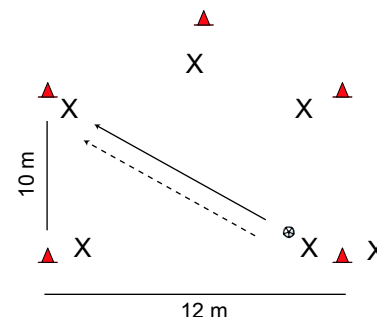

B. Runner's & Hamstring Stretches

D. Quad and Personal Stretches

Coaching Points

Agility Dribble:

1. Do this drill for about 5 minutes.
2. Ensure players change direction frequently and stop ball frequently.

Pass & Sprint Follow:

1. Passes must be accurate to feet of player waiting at cone.
2. Player must pass immediately and leave cone before next player arrives.
3. Make sure that players mix up pattern of passes, i.e. don't pass around perimeter only or always to same players. Encourage the long diagonal passes.
4. Encourage players to communicate, i.e. player who wants ball should call for it.
5. Make sure that players recognize if one player has been standing at a cone too long. That player should be most vocal to want the next pass.

Game Application

The agility dribble trains change of direction moves as well as thinking while dribbling - players have to decide to stop ball.

The pass & follow drill combines all elements of a fast attacking game. Players play two touch. Passes are diagonal or straight forward, square or backwards for support. Players must run into space after making a pass. Players receiving ball must decide where to play it next before they get it. Finally, all players must be aware of what is going on elsewhere in the field. All these elements on their own or in combination define modern soccer and serve to quickly break open defenses.

FAST BREAK SOCCER TRANSITION PLAY # 13

(3+3) v 3

3 teams of three, each team identified with different colour pinnies (practice vests).

Two attacking teams (example A and B) play against a third defending team (C).

As soon as defending team (C) wins ball, C now becomes an attacking team and the attacking team that last touched ball prior to loss of possession becomes the defending team.

Loss of possession occurs as soon as defending team touches the ball.

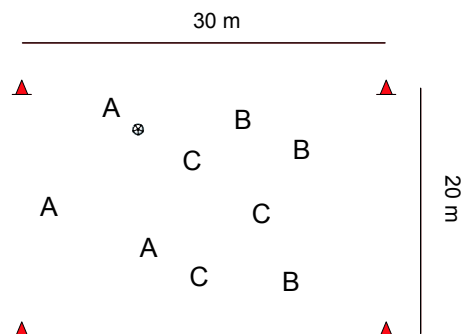

Coaching Points

1. One or two touch play.
2. Team in possession must use entire area of play and make some long passes to open players. Player passing the ball needs to envision the option for player receiving the pass. Passing into corners makes play difficult.
3. Defending team must challenge ball, close passing lanes, anticipate passes to intercept them, and put immediate pressure on player receiving ball.
4. After change of possession, the team who last touched ball must transition quickly to defend, defending team must immediately start passing. This requires a reaction from all teams. If the teams are hesitant, seem confused, can't decide, then stop play and emphasize quick decision making.
5. Group the teams according to your system of play. For example play 3 midfielders, 1 midfielder/2 strikers and 3 defenders together.
6. Depending on size of team you can set up two groups.

Game Application

Quick passing plays with minimal touches will keep defenses unsettled. Recognizing available space and playing a ball into it while a team mate makes the run to space is a building block of soccer.

Quick transition to attack after gaining possession requires fast decision making and reaction to a change of circumstance. It will catch opponents off balance and out of shape.

Defending while outnumbered occurs occasionally and this drill trains decision making (who to cover) and anticipation of runs and passes followed by quick reaction to get into best defensive shape.

FAST BREAK SOCCER SPEED # 13

Give & Go Passing

1. X passes diagonal into run of O.
2. X sprints down line.
3. X receives return pass from O.
4. O sprints down the line.
5. O receives return pass from X

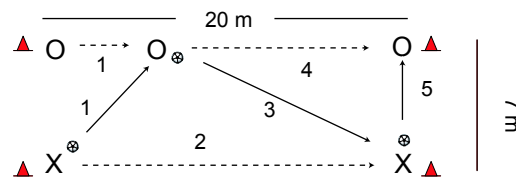

Players keep going back and forth using one touch passing

Coaching Points

1. First pass must have perfect direction and pace such that O can receive it straight in line with his/her run between cones. No waiting for ball.
2. All runs must be full out sprints - no jogging.
3. Return pass (3) must be directed to cone and arrive at same time as X.
4. For the first two minutes, emphasize accuracy over speed, then ask players to increase speed.
5. After five minutes, switch X and O so that they each get to work with both feet.
6. You may want to pair up midfielders with strikers and midfielders with defenders.
7. Ask for perfection!

Game Application

This is something you will see on TV all the time. A fast give and go is the best way to get by a defender.

Ideally, players can unlock a defense by successive give & go's working the ball into scoring position.

Accuracy of passes, weight of passes and ability to receive into the direction of the next pass are key skills.

Short sprints increase anaerobic conditioning.

FAST BREAK SOCCER GOAL SCORING # 13

Reaction Sprint & 1 v 1 On Goal

1. Two players, 5m apart, pass ball back and forth to each other.
2. At random, player facing goal passes to either left or right side.
3. One of X and O (X shown) sprints to ball while the other player sprints goal side to defend.
4. X and O now play 1v1 on goal.

Change players passing every five minutes.

Set up two groups, one at each goal.

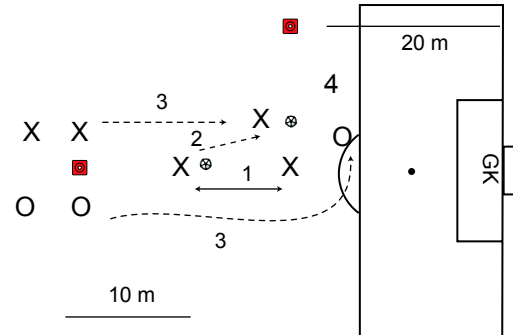

Coaching Points

1. Players passing back and forth should make the diagonal pass within 4 passes to keep drill moving.
2. The diagonal pass must remain within 2m left/right distance from passer and no more than 7m ahead. This is to allow attacker and defender to get to the 1v1 fast and execute it in a game like situation.
3. If the defender does not set up fast enough encourage attacker to take a one time shot or at most a shot on the second touch.
4. Defending player must react quickly and sprint to a goal side challenging position.
5. Players that have played the 1v1 must hurry back to end of line to keep drill flowing.

Game Application

The critical element here is the properly weighted diagonal pass into space for the deeper player to run onto.

This occurs in games when a striker receives the ball with back to goal, lays it back to a midfielder who then plays it wide to an overlapping midfielder or defender. This play can happen on the wing, in the middle or in a change of attacking direction from middle to either wing. It is also a very effective combination to beat the offside trap of a flat back defense.

Taking a shot if there is a microsecond of opportunity or only a small gap is always preferred over 1v1, because 1v1 gives all defenders and goalkeeper time to set.

FAST BREAK SOCCER GAME TACTICS # 13

5 v 4 Flank Attack

A in center circle plays a long ball to either A in a grid just outside the penalty box.

Once wide player A receives ball, defenders (D) can challenge.

A now play 5 v 4 against D.

Once D gains possession or clears ball, play restarts.

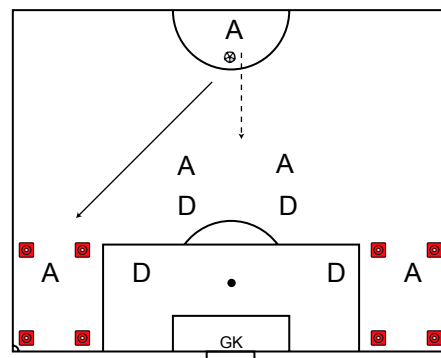

Coaching Points

1. Play a quality ball to wide player into grid - encourage high balls.
2. It is important for wide player to control ball with first touch into direction they have chosen to play. This requires decision making prior to receiving ball.
3. Defenders must hold back but react very quickly to challenge wide players as soon as they have received the ball.
4. Player in center circle joins play after pass to create the odd man advantage.
5. A's should be your strikers and midfielders.
6. You can vary the drill to a 6v4 or 5v3 or any other tactical combination according to your system of play.

Game Application

Long, high balls to the wings are a good weapon to use occasionally to quickly get past a defense.

This is seen quite frequently at the Pro levels. Passes must be into the space between the penalty box and side line to allow an overlapping player or one of the strikers enough room to outspurt a defender.

A successful 1v1 then sets up a cross into the middle, which has as many as 4 target players and a couple of trailing midfielders/defenders awaiting clearances on top of the box.

Defenders learn to challenge quickly and to cover all other players in the "danger" areas.

FAST BREAK SOCCER PRACTICE # 14

Warm Up (20 min)

A. Dribble With Body Fake

Set up as many cones as possible in half the soccer field. Each player dribbles towards a cone and body fakes one way and then dribbles ball past cone on the other side. Players must attack each cone at least once.

B. Runner's & Hamstring Stretches

C. Target Pass - Follow - Dribble

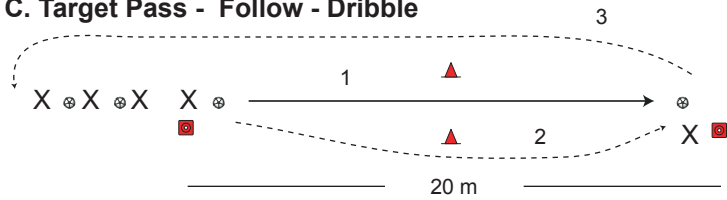

1. X passes through a 2m wide goal.
2. X collects own pass.
3. X then dribbles back to end of line.

D. Quad and Personal Stretches

Transition Play (30 min)

Two attackers play against two defenders on two full size goals. Challenging defender tries to force player with ball to side line. Second defender reads play and once play is at sideline, doubles up against ball carrying attacker. As soon as defenders win ball, they transition to attack and attackers defend.

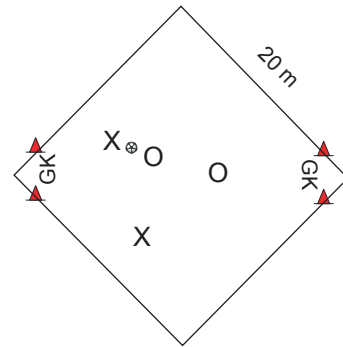

Soccer Speed (10 min)

1. X passes diagonal to O.
 2. X runs down line.
 3. O one touches back to X.
- Continuous diagonal play up and down grid.

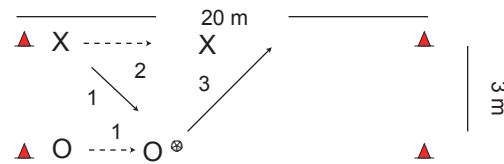

Goal Scoring (20 min)

1. Xs play 2v1 against O in grid. X's try to release one X with a pass past defender and out of grid. If defender closes down passing option, then X with ball can play 1v1 to dribble out of grid.
2. Once out of grid, X takes a shot.
3. X then heads or volleys a cross played from coach C.

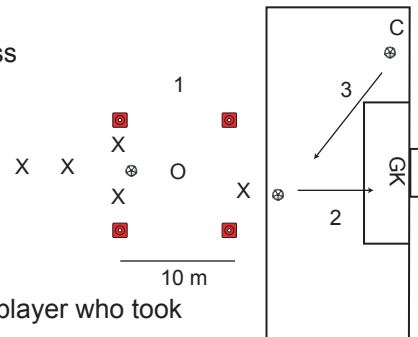

The attacker who stayed in grid is joined by another attacker. The player who took shot goes to back of line.

Game Tactics (30 min)

X play 6v6 in 50m zone in middle of field. In the example shown, X play left to right and O play right to left. Each team keeps a player outside zone defending two 3m wide goals at the top of the penalty box. Team in possession in the middle must release a player from the grid with a pass. Released player now plays 1v1 against defender trying to beat defender through one of the small goals. If successful, attacker now has a free shot on regular goal. If defender wins ball it is played to own team in middle grid. Regulation restarts.

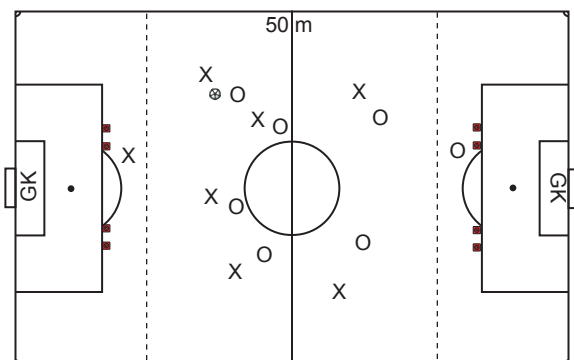

Players should be busy at all times. If drills keep players inactive, break team into smaller groups and run parallel drills.

FAST BREAK SOCCER WARM UP # 14

Body Fake Dribble & Follow Target Pass

A. Dribble With Body Fake

Set up as many cones as possible in half the soccer field.

Each player dribbles towards a cone and body fakes one way and then dribbles ball past cone on the other side.

Players must attack each cone at least once.

B. Runner's & Hamstring Stretches

C. Target Pass - Follow - Dribble

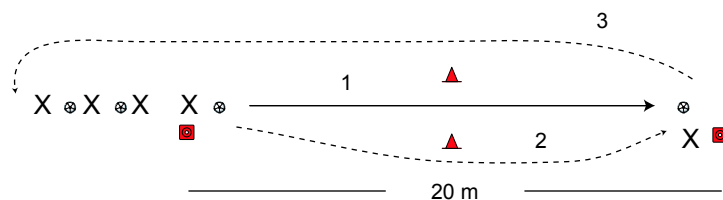

1. X passes through a 2m wide goal.
2. X collects own pass and then
3. X then dribbles back to end of line.

D. Quad and Personal Stretches

Coaching Points

Dribble With Body Fake:

1. Players dribble at high speed to cone, slow down, body fake one way, accelerate past cone on the other side.
2. Players need to keep head up while dribbling to avoid collisions, especially at cones.
3. Have at least one more cone than players. If you want to challenge players' vision ability, use less cones than players.

Target Pass - Follow - Dribble

1. No dead ball passing, touch ball ahead before passing through cones.
2. Weight of pass must be such that ball is still moving when player collects it after sprinting around cone.
3. Players must dribble back at highest speed possible.
4. If players miss small goal with passes, ask them to look up at target before passing.
5. Demand perfect execution.

Game Application

Dribbling with head up to see field and team mates for passing opportunities is the mark of a skilled soccer player. Body motion fakes will draw the defender to one side and put them in a difficult position to adjust to a quick acceleration move the other way. Examples of body fakes are upper body leaning one way, the stepover move.

Accurate passing over short distances is a critical element of maintaining possession while playing a fast attack game. Passing and following avoids "ball watching" and creates and uses space. This constant motion will make it difficult for opponents to track and mark players.

FAST BREAK SOCCER TRANSITION PLAY # 14

2 v 2 in Diamond

Two attackers play against two defenders on two full size goals.

Challenging defender tries to force player with ball to side line.

Second defender reads play and once play is at sideline, doubles up against ball carrying attacker.

As soon as defenders win ball, they transition to attack and attackers defend.

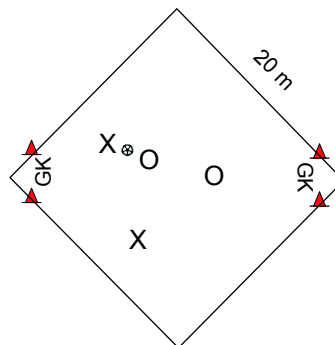

Coaching Points

1. Defenders must be angled properly in their stance to force attacker wide.
2. Second attacker must give player with ball passing options.
3. After the first defender wins ball, the second defender must release quickly to receive a break out pass into space.
4. The second attacker must react quickly to track and challenge the second defender who now has ball.
5. Goalkeepers collecting ball must roll out ball quickly to fast breaking team mates' feet.
6. Play strikers against defenders and midfielders against midfielders if possible.
7. Set up two or three fields depending on number of players.

Game Application

Forcing an attacking player to the sideline essentially takes one direction of play away from them. That presents the safest opportunity to "double up" and take the ball away. The key to this drill is the reaction speed of the defenders AFTER winning the ball. One must break out quickly into space for a pass while the attacker who lost the ball recovers from the turnover (physically and mentally).

At the same time, the supporting players of the team losing the ball must react quickly to pressure the opponent to win the ball back.

These are elemental soccer combinations, seen on TV all the time. Training to achieve perfect execution will set your team apart.

FAST BREAK SOCCER SPEED # 14

Give & Go - with Short Passes

1. X passes diagonal to O.
2. X runs down line.
3. O one touches back to X.

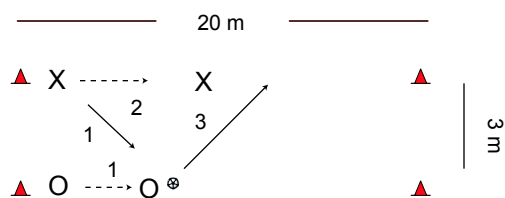

Continuous diagonal play up and down grid.

Coaching Points

1. Focus on accurate one touch passing first, then ask players to increase pace.
2. Passing must be accurate to feet and timed perfectly into runs.
3. Players need to coordinate quickly between looking at ball to receive it, looking up at target and looking back at ball to pass it.
4. There are no defenders and therefore coach must demand perfection in all aspects of executing this drill.

Game Application

Quick give and go's over short distances are effective to get out of tight situations, like the one practiced in the transition drill of this session.

By playing give and go's around a defender or multiple defenders your team can create the space necessary to mount a successful attacking play.

FAST BREAK SOCCER GOAL SCORING # 14

2 v 1 - Shoot & Convert Cross

1. Xs play 2v1 against O in grid. X's try to release one X with a pass past defender and out of grid.

If defender closes down passing option, then X with ball can play 1v1 to dribble out of grid.

2. Once out of grid, X takes a shot.

3. X then heads or volleys a cross played from coach C.

The attacker who stayed in grid is joined by another attacker.
The player who took shot goes to back of line.

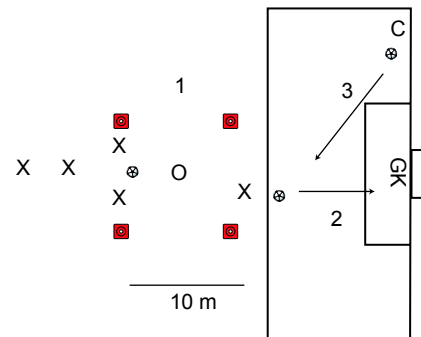

Coaching Points

1. Play in grid must be fast - no fiddling or getting tangled in 1v1. Therefore player with ball must decide quickly if the space is there to dribble past defender or if a pass is the best option.
2. Second attacker (without ball) must stay wide of player with ball to provide space for passing option.
3. After shot, player must react quickly to cross. This means "admiring" shot or goalie save is not an option. This is a difficult challenge for most players.
4. The cross should come in just outside the 5 m (6yd) box to be out of reach of the goalkeeper.
5. Player going for cross cannot overcommit, but must delay any run to judge flight of ball and run into it with maximum power.
6. Use a player to cross depending on how many players are available and how many drills you set up.
7. Minimize number of players waiting by setting multiple stations for this drill.

Game Application

Combination plays just outside the penalty box to set up a shot are amongst the most important plays in soccer. A shot from the top of the box is the best option to score a goal because it offers the striker the largest area of goal to target. Goalkeepers will have a difficult time to cut angles fast enough. Any shot into the corner virtually guarantees a goal.

The second part of the drill trains reaction speed by switching concentration from shot to observe a cross.

At the same time it trains scoring from crosses, the second most effective goal scoring play.

This drill is one of the most effective to train all elements of goal scoring in a short time.

FAST BREAK SOCCER GAME TACTICS # 14

6 v 6 + 1 v 1 With Shot

X play 6v6 in 50m zone in middle of field. In the example shown, X play left to right and O play right to left.

Each team keeps a player outside zone defending two 3m wide goals at the top of the penalty box.

Team in possession in the middle must release a player from the grid with a pass. Released player now plays 1v1 against defender trying to beat defender through one of the small goals.

If successful, attacker now has a free shot on regular goal.

If defender wins ball it is played to own team in middle grid. Regulation restarts apply after goal or out of bounds plays.

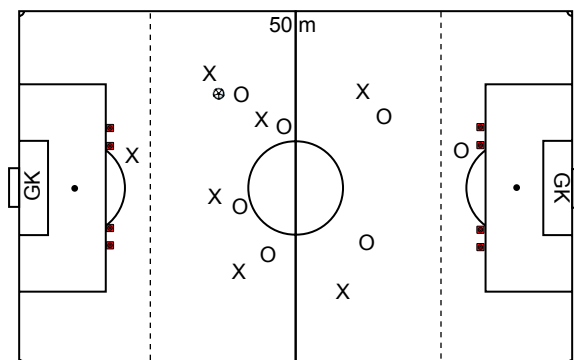

Coaching Points

1. Teams in middle must play one or two touch passing.
2. The objective is to set up as many 1v1 situations as possible. This encourages fast break attacking.
3. Players in middle must move constantly to provide FORWARD passing options.
4. Players in defending zone must move with play.
5. Ideally, the releasing pass would be in between the two wide goals to allow attacker a choice of direction.
6. In the 1v1, attackers need to be encouraged to fake play to one goal to draw in the defender, then cut back to opposite goal. This will catch defender off balance.
7. If the 1v1 bogs down, i.e. attacker is not making progress, stop play and restart. Allow no more than 5 seconds to make that judgment.
8. Make up teams in middle according to your formation, i.e. 4 midfielders + 2 strikers against 4 defenders + 2 (defensive) midfielders.
9. When defender wins ball play into middle zone must be fast to take advantage of extra player in middle.

Game Application

Quick play through the middle of the field is essential in fast break attacking soccer. Releasing a player into a 1v1 against an isolated defenders provides a high percentage option for a shot on goal.

Honing 1v1 skills and faking to one side, then going the opposite way will unbalance the defender and increase chance of setting up a shot.

Releasing different players and setting up overlapping runs are keys to unlock the defense and beating any off-side trap in a flat back defensive system.

FAST BREAK SOCCER PRACTICE # 15

Warm Up (20 min)

A. Dribbling Essentials

Each player dribbles randomly around half the field. Players switch using the inside and outside of foot as well as dribbling with left and right foot.

3-5 minutes.

C. One Touch Pass Back

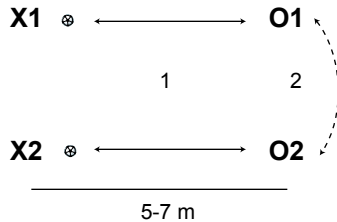

1. X1 and X2 toss ball to O1 and O2 who receive it about 10 -30 cm above ground and pass it back into hand of X1 and X2.
 2. O1 and O2 quickly change positions such that X1 now tosses to Os and X2 to O1.
- Every 60 seconds reverse roles between X's and O's.

B. Runner's & hamstring stretches

D. Quad and personal stretches

Transition Play (30 min)

6 attackers play against 4 defenders.

Play starts with goalkeeper playing ball to a defender.

Closest attacker immediately pressures defender with ball. Other attackers cover defenders and close down passing lanes.

After attackers win ball, they attack goal.

Defenders objective is to play ball through small wide goals.

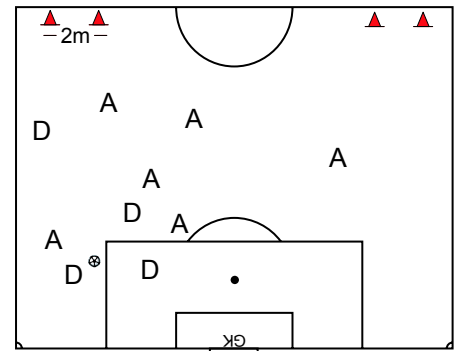

Soccer Speed (10 min)

1. O passes diagonal into run of X.
2. O makes an overlap sprint to far opposite cone
3. X passes to cone O is running to and sprints diagonal across O.
4. O passes across to X and play reverses in opposite direction.

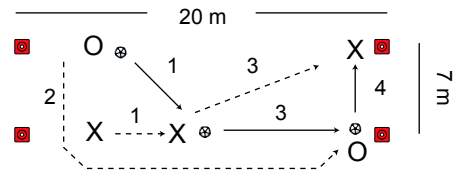

Goal Scoring (20 min)

1. Coach tosses ball over head of X who faces goal.
2. As soon as X sees ball, X reacts and controls ball.
3. X now plays 1v1 against O. O can only move in straight line between cones.

After shot or after O prevents shot, X now defends, O runs to back of line and next player X steps up.

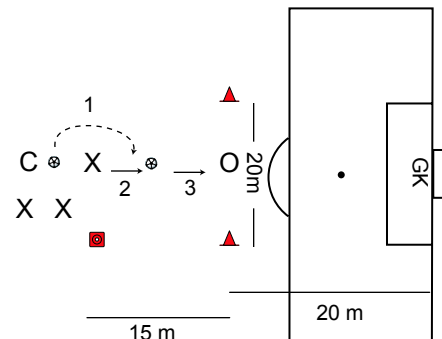

Game Tactics (30 min)

X play 4v4 against O inside penalty box.

Team in possession must play ball first to either neutral player (N) outside box.

N must cross ball in to team that played ball wide to N.

If defending teams wins possession from cross, they must play ball to N before they can score from next cross.

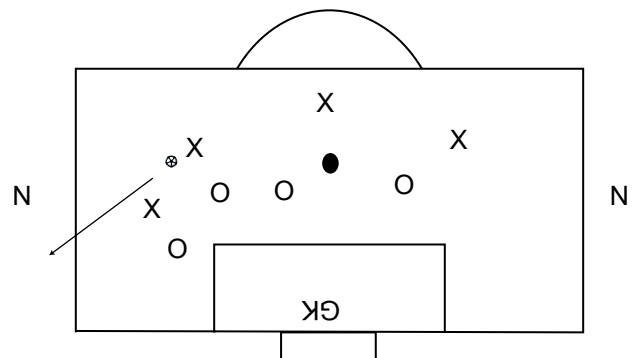

Players should be busy at all times. If drills keep players inactive, break team into smaller groups and run parallel drills.

FAST BREAK SOCCER WARM UP # 15

Dribble & One Touch Pass Back of High Toss

A. Dribbling Essentials

Each player dribbles randomly around half the field.

Players switch using the inside and outside of foot as well as dribbling with left and right foot.

3-5 minutes.

C. One Touch Pass Back

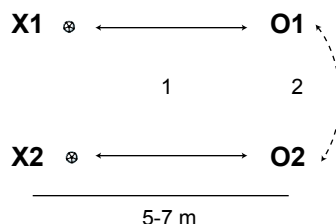

1. X1 and X2 toss ball to O1 and O2 who receive it about 10 -30 cm above ground and pass it back into hand of X1 and X2.

2. O1 and O2 quickly change positions such that X1 now tosses to Os and X2 to O1.

Every 60 seconds reverse roles between X's and O's.

B. Runner's & Hamstring Stretches

D. Quad and Personal Stretches

Coaching Points

Dribbling Essentials:

1. Encourage players to keep head up while dribbling.
2. For advanced players you can make the dribbling area smaller.

One Touch Pass Back:

1. When done well, this drill looks very fluid with players in constant motion and balls never hitting the ground.
2. The tosses must be light and accurate to receivers about 10 cm to 30 cm off the ground.
3. The touch back should be with instep for maximum control and be straight back to hands.
4. The receiving players must coordinate the switch of position and the timing between them and the players tossing ball must be perfect. The tosses must always be at the same time.

Progression suggestion: a. Toss ball to head for headers back.
b. Have players touch back with alternating feet.

Game Application

Advanced players must know how to dribble with both feet, inside/outside foot while keeping head up to maintain vision of field and players around them.

Tossing drill's most obvious application is the throw-in. Players often receive a throw in and the only option is to play it back to the thrower with one touch.

At the same time the tossing drill develops agility and coordination.

FAST BREAK SOCCER TRANSITION PLAY # 15

6 v 4 Pressing & Counterattack

6 attackers play against 4 defenders.

Play starts with goalkeeper playing ball to a defender.

Closest attacker immediately pressures defender with ball.
Other attackers cover defenders and close down passing lanes.

After attackers win ball, they attack goal.

Defenders objective is to play ball through small wide goals.

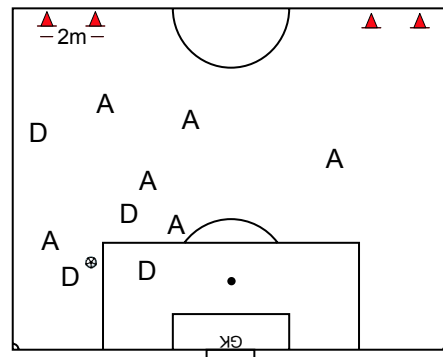

Coaching Points

1. When defenders have possession, players without ball must move to open up "safe" passing options. Passes back to the middle in front of own goal are least favoured. A turnover here can be fatal.
2. Attackers pressuring defender with ball must close defender down as fast as possible to prevent a break out pass. This is because attacking players are committed forward and if defenders are successful in passing out, then the counterattack will leave the attacking team off-balance and vulnerable.
3. Attackers therefore must have one player challenging the defender with ball, a second player "doubling up" and all others must cover and at the same time close down passing lanes.
4. Defenders must play ball out through small goals as fast as possible.
5. If attackers win ball, they must transition to generate a shot on goal as quickly as possible. Having compressed the field of play to pressure defense, they now must open up spaces.
6. Do not allow attackers to avoid shots from opportune areas - they need to develop a "killer instinct"

Note: If attackers are out of position and too far away from ball carrying defender, you may ask them to consider to abort the "high pressure" play and drop back to more conservative positions.

Game Application

Applying high pressure to defenders in their attacking zone is very effective to maintain the momentum of the attack. It is also risky in that if the defenders can play the ball out, the midfield can be open for a fast counterattack. Therefore, high pressure is most successful if defender with ball can be "trapped" near the side line or in the spaces between penalty box, side line and goal line.

An attempt at high pressure can be made in a central area between penalty box and half line, but if opposing defenders work the ball past the initial pressure, then a retreat and more conservative challenge should be considered. This decision making process will be trained in this drill.

FAST BREAK SOCCER SPEED # 15

Overlap Sprints

1. O passes diagonal into run of X.
2. O makes an overlap sprint to far opposite cone
3. X passes to cone O is running to and sprints diagonal across O.
4. O passes across to X and play reverses in opposite direction.

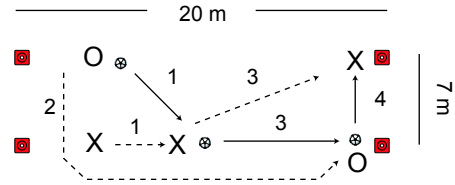

Coaching Points

1. Passing must be precise and timed to arrive at the target point at the same time as the runner.
2. The overlapping sprint must be at the highest pace the runner is capable of.
3. Player X in the example shown must pass right away to the cone ahead to allow/force O to sprint to it before it rolls past cone.
4. X must sprint diagonal to cone to be ready to receive square pass from O.
5. The first touch of X should be slightly away from the overlapping run of O to allow for more fluid passing and better protection of the ball in a game situation.

Game Application

Overlapping runs are a very standard play by just about every competitive team. Overlaps are done by defenders all the way to the opposite goal line for crosses, or by midfielders.

The key to successful overlaps is a precision pass and a sprint by the overlapping player to catch the defenders off balance.

FAST BREAK SOCCER GOAL SCORING # 15

Reaction Control - 1v1 - Shot

1. Coach tosses ball over head of X who faces goal.
2. As soon as X sees ball, X reacts and controls ball.
3. X now plays 1v1 against O. O can only move in straight line between cones.

After shot or after O prevents shot, X now defends, O runs to back of line and next player X steps up.

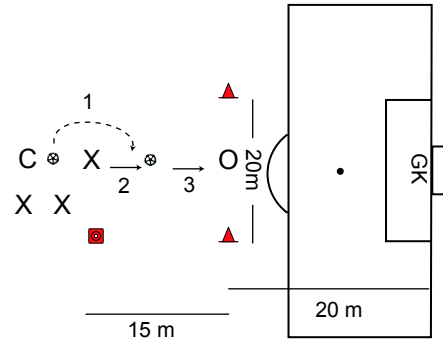

Coaching Points

1. The throw over the head of the attacker must be a high, soft "lob" and land within 2-4 m in front of player.
2. Attacker cannot turn head to look for tossed ball, but must be focussed straight ahead. This employs peripheral vision and trains reaction speed.
3. Once player sees ball, they must control ball with one touch to set up the 1v1.
4. Encourage attacking player to use fakes to get by defender.
5. Ensure defender stays on line between cones to give advantage to attacker. The ultimate objective of this drill is to score a goal.

Variation suggestion: Instead of throwing ball overhead, pass it on ground to either side.

Instead of coach tossing ball, use players and rotate them in as appropriate.

Game Application

Players frequently get into a position to see a ball in their periphery and then needing to react to it.

1v1 situations outside the penalty box are a high percentage play to set up a successful shot on goal.

Training players to be ready to transition to defense immediately after shooting is important and tends to be very difficult for players. It requires high level of discipline, concentration and reaction speed.

FAST BREAK SOCCER GAME TACTICS # 15

4 v 4 & 2 Neutrals Flank Attack

X play 4v4 against O inside penalty box.

Team in possession must play ball first to either neutral player (N) outside box.

N must cross ball in to team that played ball wide to N.

If defending teams wins possession from cross, they must play ball to N before they can score from next cross.

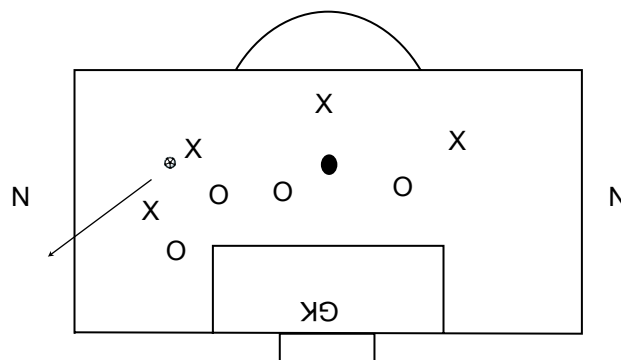

Coaching Points

1. Neutral players will tend to stand around waiting for pass. They must be fully engaged in the play by moving up and down the line to generate the best angle possible for the pass. They need to be vocal in directing play and communicating to player in possession that the "pass is on".
2. Encourage team in possession to switch play to the opposite neutral player. This opens up spaces in front of goal for a more successful cross.
3. Players must concentrate to keep track of which team can score off the cross and which team, after winning cross, must play it back wide.

Suggestions:

1. Rotate players in and out of neutral position.
2. Mix up the teams such that defenders, midfielders and strikers are on each team.
3. Use your starting 11 players for this drill and have the rest of the team do another drill. Then rotate players in and out of this drill, like making substitutions in a game.

Game Application

When play gets tight or "bogged down" inside the penalty box, an effective way to spread the defence and create space is to play the ball wide for a quick cross.

The wide player receiving the ball can be a striker making a diagonal run thus opening up space in the middle for a deep run from the midfield. Or it can be an overlapping defender or midfielder who is wide open because the sprint down the line left their marking player behind.

FAST BREAK SOCCER PRACTICE # 16

Warm Up (20 min)

A. Take-over Dribble

Each player dribbles a ball in a 25m x 25m grid.

On coach's command, players take over someone else's ball and keep dribbling.

B. Runner's & hamstring stretches

C. Take-over Dribble 2

Same dribbling exercise as A.

This time two players do not have a ball, they must jog until "take-over" command. The objective for players with ball is to not be the players without a ball after the take-over.

D. Quad and personal stretches

Transition Play (30 min)

Play in an area twice the size of penalty box as shown.

3 X play vs 3 O, each team has a target player Tx and To.

Target players must stay in the attacking half. Teams can only score with all players across the half line. Therefore play on goal is always 4v3. Upon defending team gaining possession, they must get pass to target player as soon as possible. Score 1 point for a regular goal, 2 points for goal after a give and go with target player.

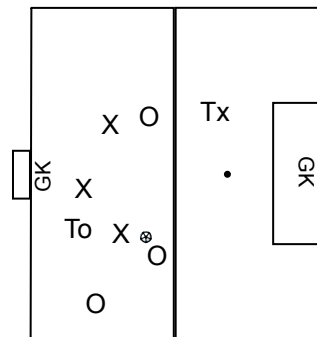

Soccer Speed (10 min)

1. X passes to open cone to the left and O sprints to ball.
2. O plays it back to X with one touch.
3. O then immediately turns and sprints back to starting cone.
4. X now plays to cone on right. Go for 60 seconds and switch roles.

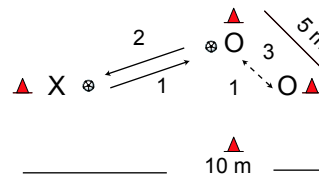

Goal Scoring (20 min)

1. A2 dribbles towards D2 who is approaching A2
2. Just before D2 gets to A2, A2 passes diagonal to A1.
3. A1 has made a run into space, followed by D1
As soon as A2 passes, A2 sprints around outside of D2.
4. A2 receives diagonal pass from A1
5. A2 finishes with shot on goal.

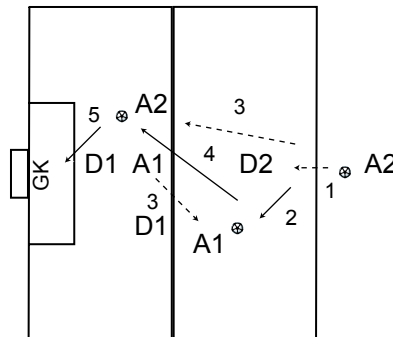

Game Tactics (30 min)

7 v 7 play on 3/4 field.

Cones along both sides mark a free passing lane.

A player from either team receiving ball in passing lane cannot be challenged and gets a free cross.

Goals scored from crosses count as 2 pts, regular goals count 1 pt.

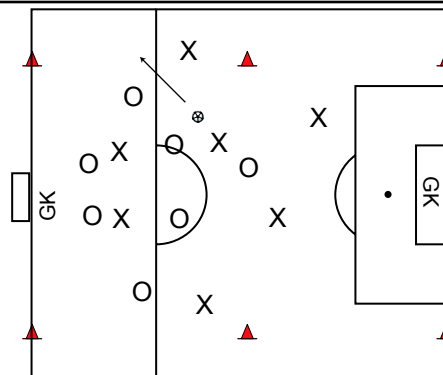

Players should be busy at all times. If drills keep players inactive, break team into smaller groups and run parallel drills.

FAST BREAK SOCCER WARM UP # 16

Take-over Dribble

A. Take-over Dribble

Each player dribbles a ball in a 25m x 25m grid.

On coach's command, players take over someone else's ball and keep dribbling.

C. Take-over Dribble 2

Same dribbling exercise as A.

This time two players do not have a ball, they must jog until "take-over" command. The objective for players with ball is to not be the players without a ball after the take-over.

B. Runner's & Hamstring Stretches

D. Quad and Personal Stretches

Coaching Points

1. Ensure players dribble with head up to be aware of other players' positions.
2. Vary time between commands, including some very short ones.
3. Encourage players to dribble at highest possible pace.
4. Ask players to prevent running into each other (body or ball)
5. adjust size of area to best fit the number of players and their skill level.

Game Application

Take-over moves are excellent opportunities to confuse opposing defenders. Players taking over the ball must accelerate away into space immediately after the take-over.

This drill trains reaction speed (to coach's command); decision making speed (which ball to take); and perception speed (turning information into a mental picture), all important mental aspects of modern soccer.

FAST BREAK SOCCER TRANSITION PLAY # 16

4 v 3 with Target Player

Play in an area twice the size of penalty box as shown.

3 X play vs 3 O, each team has a target player Tx and To.

Target players must stay in the attacking half. Teams can only score with all players across the half line. Therefore play on goal is always 4v3.

Upon defending team gaining possession, they must get pass to target player as soon as possible.

Score 1 point for a regular goal, 2 points for goal after a give and go with target player.

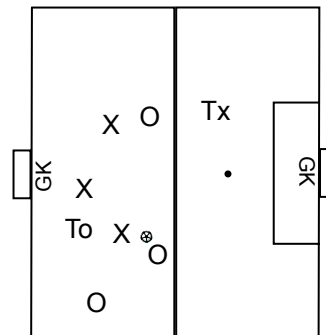

Coaching Points

1. Team in possession in attacking zone plays 4 v 3 and must use the width of the field to create space. They must be in continuous motion to get the extra player into space to receive a pass.
2. Remind players that they are in the penalty box when attacking and if there is a good angle to goal they need to shoot.
3. The target player staying on the other side must move laterally with the play to be in position to receive a quick break-out pass after change of possession.
4. After gaining possession, the defending team must pass out quickly. At the very latest the second touch must be the pass to the target player.
5. Players tend to make the pass out and then stand and watch. Encourage them to sprint out of their zone to set up the fast break.
6. Maximum of two touches per player.
7. Suggested set up of teams: Target player = striker, 2 midfielders, 1 defender; vary to your preference

Game Application

Playing the ball quickly into the opposing penalty box sets up more scoring chances and therefore increases likelihood of scoring more goals.

Fast break attacks after gaining possession catches opponents off-balance.

A lot of teams are very good defending when outnumbered, and this drill trains how to defend in that situation. At the same time teams struggle scoring goals when in odd man advantage situations.

These situations need to result in goals.

FAST BREAK SOCCER SPEED # 16

Sprint - Pass Back - Turn - Sprint

1. X passes to open cone to the left and O sprints to ball.
 2. O plays it back to X with one touch.
 3. O then immediately turns and sprints back to starting cone.
 4. X now plays to cone on right.
- Go for 60 seconds and switch roles..

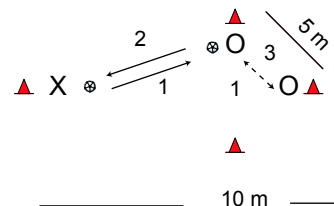

Coaching Points

1. Pass to open cone must be weighted to arrive at same time as sprinter.
2. Sprints to cone must be "all out".
3. After sprinter passes back, they must cut back sharply, sprint to starting cone, turn and sprint to open cone.
4. Passers tend to try to make it easy for working player by waiting for their runs. They need to lead them with their passes and challenge them to react quickly and keep the work rate high.

Game Application

Timing passes and runs into space such that receiver can continue play without interruption is a key combination skill. The other important element trained in this drill is players checking (running) into space, quickly turning and running into a different direction. The underlying concept is using available space to set up further plays.

FAST BREAK SOCCER GOAL SCORING # 16

2 v 2 Give And Go With Overlap

1. A2 dribbles towards D2 who is approaching A2
2. Just before D2 gets to A2, A2 passes diagonal to A1.
3. A1 has made a run into space, followed by D1
As soon as A2 passes, A2 sprints around outside of D2.
4. A2 receives diagonal pass from A1
5. A2 finishes with shot on goal..

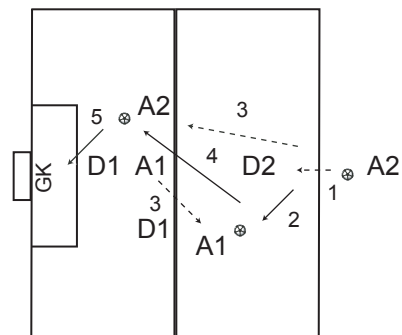

Coaching Points

1. Timing of all runs is critical to the success of this drill.
2. A1 must run into space and A2 must read A1's run to time the pass past D2.
3. D1 initially plays a passive defending role until passing works. Then D1 can increase pressure.
4. As soon as A2 passes the ball, A2 must make the overlapping sprint. However, A2 must keep an eye on A1 to ensure the pass through the gap is actually happening. If it is not, A2 must retreat to restart play.
5. Mix up the attacking players who are combining. You can play with 2 strikers, 1 midfielder/1 striker or 2 midfielders.
6. The critical element to success is the return pass from A1 to A2. The covering defender D1 will attempt to block the pass by sticking their leg out or making a sliding tackle. A1 therefore needs to sprint to the ball staying inside the defender and lift the ball about 30 cm off the ground with the pass or play it on ground faster than D2 can defend. If D1 overplays the initial pass, allow A1 to turn on the defender and play a delayed but easier pass to A2.
7. D2 must challenge initial pass from A2, but cannot cheat by closing off A2's passing lane.

Game Application

The combination of a give and go with an overlap is an excellent play to unlock a defense. In particular, defender D2 will be caught on their heels and have a difficult time reacting to an explosive run by A2.

A2 will be in a good position to take a direct shot on goal.

FAST BREAK SOCCER GAME TACTICS # 16

7 v 7 With Free Crosses

7 v 7 play on 3/4 field.

Cones along both sides mark a free passing lane.

A player from either team receiving ball in passing lane cannot be challenged and gets a free cross.

Goals scored from crosses count as 2 pts, regular goals count 1 pt.

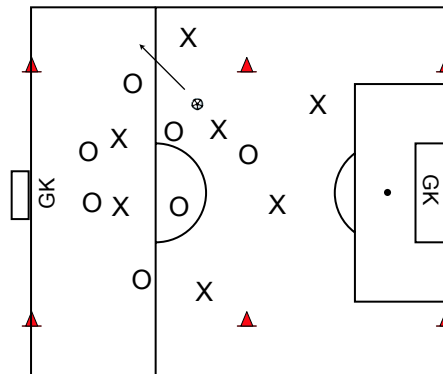

Coaching Points

1. Teams must use full playing area, tendency may be to bunch up on one side.
2. Switching play with one or at most two passes from one side all the way across into the opposite free passing lane will open up play and generate clear crossing or passing opportunities into the penalty box.
3. Players must communicate to ensure one player is always ready to run into passing lane to receive ball.
4. Players cannot stand in passing lane waiting for ball, they must run into that space to receive a pass.
5. Teams need to mix plays to passing lane with quick combination plays through the middle.
6. Play according to your system of play. A suggestion is that one team play with 4 defenders, 2 midfielders and 1 striker against 1 defender, 4 midfielders and 2 strikers.
7. Encourage overlapping runs by defenders and midfielders, and diagonal runs by strikers, into passing lanes.

Progression suggestion: Allow defending team into passing lane to challenge.

Game Application

Varying the point of attack from side to side and through the middle makes a team less predictable.

Varying the positions of players can open up valuable attacking spaces. For example a central striker making a diagonal run to the flank can open up space in the middle that a midfielder can push into for a scoring opportunity. Defenders can overlap for crossing plays as well.

It is important that your team keeps transition to defense in mind should they lose possession. This means that those overlapping players must be covered by team mates until they return to their regular positions.

FAST BREAK SOCCER PRACTICE # 17

Warm Up (20 min)

A. Stop And Go Dribble

Players dribble ball across field pushing it forward with laces, stopping with sole of foot.

On the way back use other foot.

B. Runner's & hamstring stretches

C. 1v1 Moves

Players play with partners facing each other.

One player has ball, the other player is defender.

Player with ball tries to beat defender with their favourite 1v1 move.

Change roles after each attempt.

D. Quad and personal stretches

Transition Play (30 min)

Split team into two groups. Place 6 goals, 5 m wide, randomly across field.

Teams score goals by passing ball through a small goal to a team mate. Teams cannot pass through same goal twice in a row.

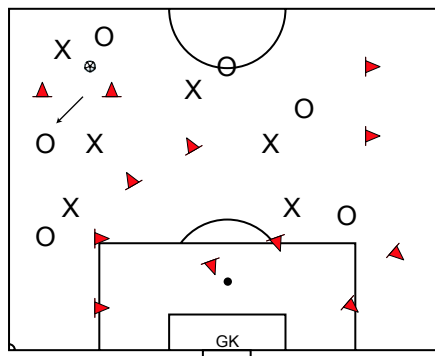

Soccer Speed (10 min)

3 v 1 in a 10 m by 10 m grid.

Players in possession play with maximum two touches and get 1 pt for every five consecutive passes. If defender wins ball, it is played back to attackers.

Rotate players to defense every 2 minutes, each player getting one defending turn

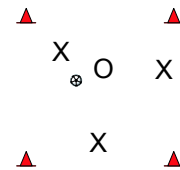

Goal Scoring (20 min)

Two groups work at the same time.

1. Dribble towards near cone.
2. Change direction and dribble to far cone
3. Change direction and dribble diagonally through cones.
4. Shot on goal.
5. Sprint to end of opposite line

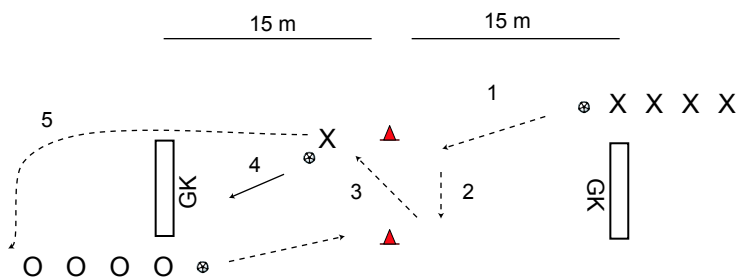

Game Tactics (30 min)

Teams play in one half of field.

On command by coach, team in possession breaks across into other half trying to score.

Other team tries to win ball and score in same goal.

Team that breaks out gets 2 pts for a goal, other team gets 1 pt.

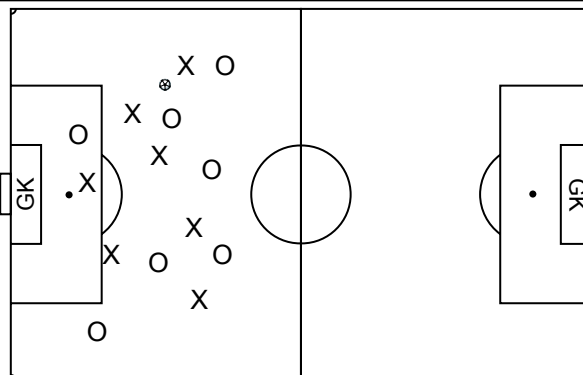

Players should be busy at all times. If drills keep players inactive, break team into smaller groups and run parallel drills.

FAST BREAK SOCCER WARM UP # 17

Stop & Go Dribble; 1v1 Moves

A. Stop And Go Dribble

Players dribble ball across field pushing it forward with laces, stopping with sole of foot.

On the way back use other foot.

C. 1v1 Moves

Players play with partners facing each other.

One player has ball, the other player is defender.

Player with ball tries to beat defender with their favourite 1v1 move.

Change roles after each attempt.

B. Runner's & Hamstring Stretches

D. Quad and Personal Stretches

Coaching Points

Stop And Go Dribble:

1. Players must keep ball close to foot.
2. The stop with sole must instantly be followed by continued dribble - no delay.
3. Pick up pace of dribble if Stop/Go move is perfectly fluent.

1v1 Moves

1. Use body fake one way to set up move past defender the opposite way.
2. Players must decide quickly which move to use and then execute it at high pace.

Game Application

Stop And Go dribbles are one of many moves to fake a defender. The hope is that the defender has overcommitted and overruns the play. That should provide space for the attacker to dribble into space or play a high percentage pass.

1v1 moves are essential tools for attacking players to beat a defender to set up a dribble, pass, cross or shot.

Attacking players should be encouraged to take on defenders in the attacking third of the field whenever an opportunity presents itself.

FAST BREAK SOCCER TRANSITION PLAY # 17

Two Teams Play Through 6 Goals

Split team into two groups.

Place 6 goals, 5 m wide, randomly across field.

Teams score goals by passing ball through a small goal to a team mate.

Teams cannot pass through same goal twice in a row.

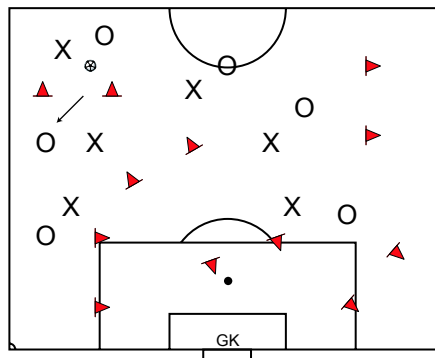

Coaching Points

1. Tendency is for players to bunch up around the goal that is being attacked. Encourage players to use the entire field. For example, players from the team in possession and attacking a specific goal should make runs to one of the other goals for a switch in play, a long pass or a succession of short passes. This provides more scoring opportunities.
2. After a goal is scored, team that scored is still in possession and must keep pace of play high by immediately attacking another goal.
3. After a change of possession, the team that was defending must immediately transition to attacking. They must quickly identify, as a team aided by communication, a goal in an open space and shift play with as few passes as possible to that goal.
4. Encourage teams to attack one goal, pull ball back (see warm up dribble) and play a pass into available space.

Variation: Use one or two full width goals with goalkeepers and award two points for scoring in a large goal.

Game Application

This drill trains variation of attacking plays by changing points of attack quickly. This is a key element in opening space and leaving defenders out of position. It also sets up odd man advantages if switching play is combined with overlapping runs to set up 2v1 or 3v2 situations. Players need to have the vision to see available space while attacking a particular area.

The faster a team winning the ball can transition to attack the more likely that they will catch the opponents off-balance. It is not enough to just win possession of the ball, it is critical that players react quickly to the fact that they now need to change their focus and concentration to quickly move the ball toward the opponents goal. Likewise, the team that just lost possession must immediately take on a team defensive shape and apply principles of challenging player with ball and covering all others. They need to move goal side of ball AND opponents.

FAST BREAK SOCCER SPEED # 17

3 v 1 in Grid

3 v 1 in a 10 m by 10 m grid.

Players in possession play with maximum two touches and get 1 pt for every five consecutive passes.

If defender wins ball, it is played back to attackers.

Rotate players to defense every 2 minutes, each player getting one defending turn

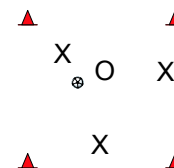

Coaching Points

1. One touch passing by players in possession.
2. Defending player must challenge player who just received pass. The key for the defender is to decide if they should commit to a tackle or stay back a bit to close down passing angles to play an interception on the next pass. This decision is based on the level of control the receiving player has. If the ball is just bouncing a little bit or moves away from receiver such that receiver needs a second or third touch, then the opportunity for a tackle exists.
3. Players in possession must be in constant motion to open up wide passing angles for player with ball.
4. It is recommended that the second attacker offers a supporting angle (square pass) and the third attacker a longer passing option.
5. Defenders can be discouraged if the passers are highly skilled and they may tend to quit. Encourage them to keep going at full effort.

Game Application

The team in possession must always create passing options for the ball carrier. This drill allows players to develop that perception of space and passing angle with relatively minor pressure. In a game, the rule of thumb is that the player with the ball has at least three passing options. One a "support" pass to a player behind them, one a "build-up" pass to a player to the left or right and one an "attacking" pass to a player ahead.

Defenders first responsibility is to slow down the player with the ball, i.e. preventing a dribble past or a pass.

The second responsibility is to make a tackle to win the ball. The decision to tackle must be based on the opponent losing tight ball control to ensure a high chance of success. Otherwise the defender will be passed and taken out of the play.

FAST BREAK SOCCER GOAL SCORING # 17

Change Of Direction Dribble & Shot

Two groups work at the same time.

1. Dribble towards near cone.
2. Change direction and dribble to far cone
3. Change direction and dribble diagonally through cones.
4. Shot on goal.
5. Sprint to end of opposite line

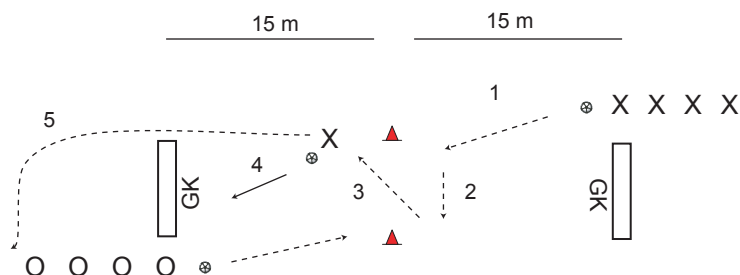

Coaching Points

1. Dribbles must be at high pace without losing control of ball.
2. Players must keep head up to avoid collisions between the cones.
3. The change of direction move at the cone (3) must be sharp, quick, without wide turns. A sharp cut or a pull-back move are good options.
4. Players need to set up the shot with a diagonal touch slightly ahead and away from direction of shot.
5. Players must look at target prior to shooting, target must be the far post.
6. Players should pick up their ball on the way to the end of the line.

Game Application

Inside the penalty box players must think shot on goal, as long as they have a good angle on goal. The target area from which to shoot under ideal circumstances is an area defined by a line from each top corner of the 5m (6yd) box to the corresponding corner of the D at the top of the penalty box.

Players need to make a quick move, with or without a following dribble, to fake out the defender in front of them enough to open up a gap for a shot.

Attacking players may be surprised at how little space is needed to get a clear shot when change of direction is quick.

FAST BREAK SOCCER GAME TACTICS # 17

Quick Transition Team Attack

Teams play in one half of field.

On command by coach, team in possession breaks across into other half trying to score.

Other team tries to win ball and score in same goal.

Team that breaks out gets 2 pts for a goal, other team gets 1 pt.

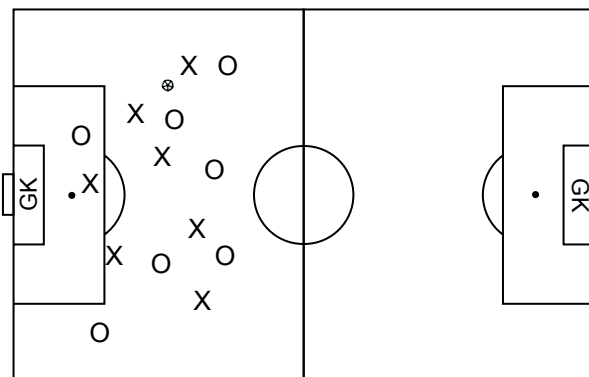

Coaching Points

1. Team in possession must play one/two touch passing utilizing the entire space available.
2. Teams must react quickly, as a unit, to command of coach to attack. Defending team must react just as quickly. Make sure no players stay behind or miss the signal.
3. Defending team must sprint at full speed to get goal side of attackers who break.
4. The team that reacts fastest to the "break out" will likely be the one scoring.
5. After a goal is scored or ball goes out of play, regular possession rules apply and play is restarted.
6. Coach can use command to "break out" at any time, for instance just after teams broke and crossed half. Also interesting is a command just after a change of possession. To stay with the spirit of Fast Break Soccer, give the command as often as practical to avoid turning this drill into a possession drill.
7. If there are more players, either increase number of players per team or substitute on the fly.

Game Application

This drill trains the pace of transitioning from own half to attacking the opponent's goal. The faster the break out, the higher the chance of "overrunning" the defense. At the same time, teams must be prepared to transition to defending as fast as possible.

Teams are encouraged to switch points of attack and are required to make supporting runs into nspace to provide options and maintain possession. The goal is to attack opponents so quickly that they have no opportunity to regain their balance or shape.

FAST BREAK SOCCER PRACTICE # 18

Warm Up (20 min)

A. One Touch Passing

In pairs, facing each other 5 m apart, players one-touch pass the ball to each other while shuttling (side step) from the goal line to center field and back.



B. Runner's & hamstring stretches

C. "Man On" Pass Or Turn

- X passes to O and calls either "man on" or "turn"
- 2a. If "man on" O one touch passes ball back to X
- 2b. If "turn", O turns, dribbles a few steps, then turns again and passes to X

When O passes, O now makes the call

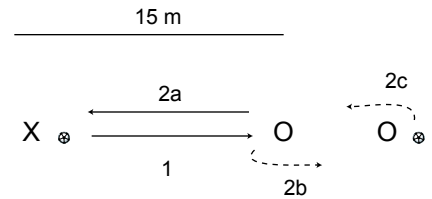

D. Quad and personal stretches

Transition Play (30 min)

1. X dribbles down line to cross a ball from close to goal line.
2. O times run to far post.
3. O receives cross from X.
4. O finishes the cross and sprints to touch post, turns.
5. X picks up another ball, dribbles back while O runs back to receive a cross from X on other goal. X and O switch places while the next pair goes down for a cross and finish.

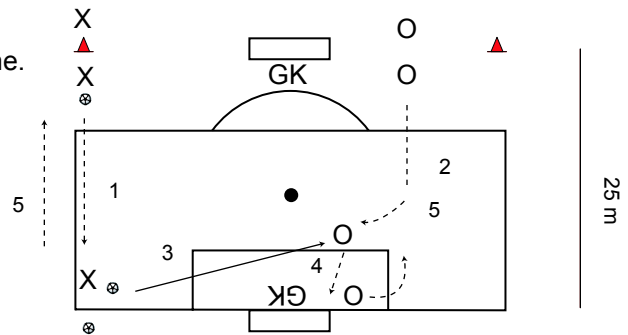

Soccer Speed (10 min)

1. Speed dribble to first cone, cut left
2. Dribble to cone on left and cut back 180 degrees
3. Dribble across to far cone and cut back 180 degrees
4. Dribble to center cone, turn and
5. Dribble to top cone

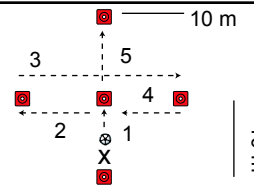

Goal Scoring (20 min)

1. X passes to O and follows pass.
2. O lays ball off diagonally into run of X.
3. X takes a one touch shot on goal.

Alternate sides. Everyone takes the spot of O.

After shot, players sprint to back of opposite line.

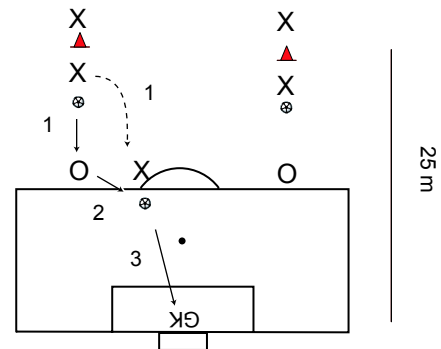

Game Tactics (30 min)

Server (S) plays ball to one of the attackers (A) who must stay outside of the penalty box.

Attackers play 3v2 against defenders on goal.

If defenders win ball, they play it out to S who restarts play.

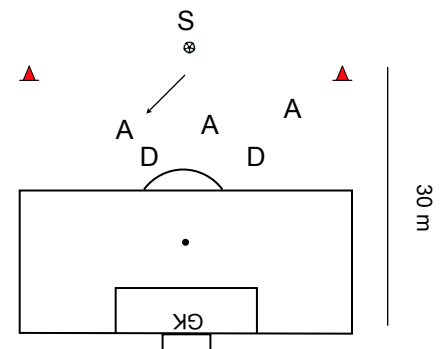

Players should be busy at all times. If drills keep players inactive, break team into smaller groups and run parallel drills.

FAST BREAK SOCCER WARM UP # 18

Passing & "Man On" Pass or Turn

A. One Touch Passing

In pairs, facing each other 5 m apart, players one-touch pass the ball to each other while shuttling (side step) from the goal line to center field and back.



C. "Man On" Pass Or Turn

1. X passes to O and calls either "man on" or "turn"
- 2a. If "man on" O one touch passes ball back to X
- 2b. If "turn", O turns, dribbles a few steps, then turns again and passes to X

When O passes, O now makes the call

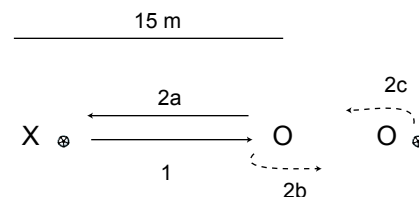

B. Runner's & Hamstring Stretches

D. Quad and Personal Stretches

Coaching Points

One Touch Passing:

1. It is important that players maintain a constant distance to each other as they shuttle down the field and back.
2. Challenge players to pass with accuracy to keep moving fluidly, without waiting for ball or sprinting to catch up to it.

"Man On" Pass Or Turn

1. Players must keep the passing distance constant, use flat cones as markers if necessary.
2. Players must give the instruction loudly and clearly as soon as ball leaves their foot so that receiving player has time to react to the instruction.
3. Stress accuracy before speed and "fancy" turns, simple pull-back or cut back turns are best.

Game Application

Passing accuracy is a key building block of soccer. These drills emphasize the maintenance of distance between players. This trains spacial awareness while working with the ball.

The "man on" or "turn" is one of the most fundamental communications between players during a game.

The mental speed at which a tammate's command is understood and converted to action is an important element of fast break soccer.

It seems simple but when forgotten, opponents will sneak up and steal the ball. It is an excellent habit to reinforce at all times.

FAST BREAK SOCCER TRANSITION PLAY # 18

Dribble-Cross-Finish-React-Repeat

1. X dribbles down line to cross a ball from close to goal line.
 2. O times run to far post.
 3. O receives cross from X.
 4. O finishes the cross and sprints to touch post, turns.
 5. X picks up another ball, dribbles back while O runs back to receive a cross from X on other goal.
- X and O switch places while the next pair goes down for a cross and finish.

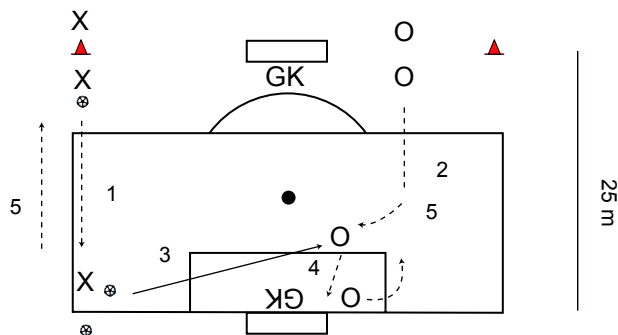

Coaching Points

1. This drill is a recap of one of the fundamental building blocks of transition play: a fast change of direction after completing a play. In this case both X and O transition back into the direction they came from.
2. O's will initially forget to follow through and touch the post after their attempt on goal. This is a natural response to a situation where they know they must quickly transition back. This drill therefore trains attentional control and concentration.
3. The crosses can be high or low. It is important that the timing of O is such that O reads the speed and direction of the cross to allow for a powerful approach into the strike.
4. X's may stop and admire or watch the result of their cross. If they do, they will slow down the fast break into the other direction. Remind them to get the 2nd ball immediately after the cross is taken so that O does not have to wait for delivery of the second cross.

Game Application

After loss of possession close to the opponents goal (goalie save, out of bounds ball, successful tackle by defender), it is critical that players turn and retreat quickly into their defensive positions. Even strikers who followed through on a second effort must now get back. Quite often players lag behind, watch the next play develop and do not "hustle" back. This allows the opponent to mount a successful counterattack.

The crossing and finishing part of this drill trains a very important attacking element of soccer. The key point, however, is the quick retreat after a completed play.

Players can also benefit from training the quick change of direction/transition from defense to offense. A defending midfielder must turn and sprint to open the field after watching their goalkeeper or defender gain possession.

FAST BREAK SOCCER SPEED # 18

Sprint Dribble With Turns

1. Speed dribble to first cone, cut left
2. Dribble to cone on left and cut back 180 degrees
3. Dribble across to far cone and cut back 180 degrees
4. Dribble to center cone, turn and
5. Dribble to top cone

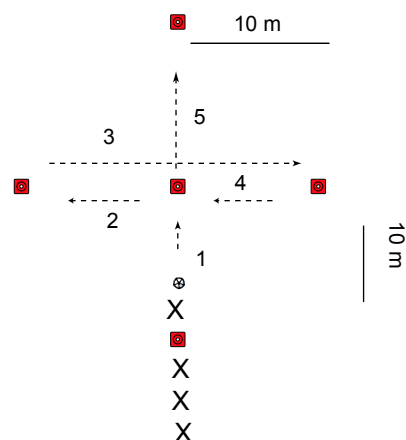

Coaching Points

1. Dribbles must be as fast as possible while keeping tight control of the ball.
2. Turns must be executed very sharply to keep the dribbles between the cones.
3. Players need to look up to see the cones.
4. When a player turns to start the last dribble (5), the next player can start.
5. After the last dribble, players dribble back to end of line.
6. No more than 4 players per group

Game Application

High speed dribbles with sharp changes of direction are the hallmarks of excellent soccer players.

Ronaldo, Ribery, Ronaldinho and your future stars exhibit this skill which gets them past defenders to set up a lethal pass or a clinical finish. Keeping tight control of the ball is critical.

FAST BREAK SOCCER GOAL SCORING # 18

Pass - Lay-Off - Shot

1. X passes to O and follows pass.
2. O lays ball off diagonally into run of X.
3. X takes a one touch shot on goal.

Alternate sides. Everyone takes the spot of O.

After shot, players sprint to back of opposite line.

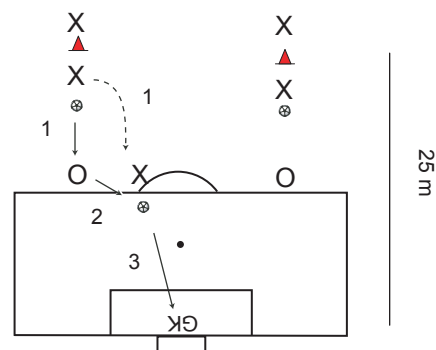

Coaching Points

1. This is a fundamental shooting drill, therefore perfection is the only valid result.
2. Players may tend to slack off, so challenge them to execute consistently well.
3. The pass to O must be on the ground and properly paced to allow O to make a simple, soft lay off pass with one touch.
4. X must time their run to strike a slightly moving ball with full power.
5. Shots must be aimed inside far post.
6. You will likely be surprised at the number of misses (shots right at goalkeeper, wide or above net).

Variation: Play without goalkeeper, put a cone 1 m inside each post and ask players to shoot between cone and post.

Game Application

Playing a ball into a striker who plays it back or diagonal to the player who passed it, or to a third player running in, is a very effective combination play for a shot on goal. In game situations, the marking will be tight and the spaces constricted. Therefore passing accuracy and timing of runs is vital. This drill trains this very fundamental skill to perfection.

FAST BREAK SOCCER GAME TACTICS # 18

3 v 2 With Shot On Goal

Server (S) plays ball to one of the attackers (A) who must stay outside of the penalty box.

Attackers play 3v2 against defenders on goal.

If defenders win ball, they play it out to S who restarts play.

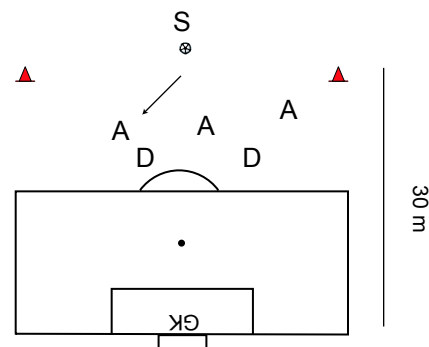

Coaching Points

1. Attackers (A) must move away from each other to create space giving the server (S) at least two passing options.
2. The 3v2 must be carried out with quick one/two touch passing to set up a clear shot on goal.
3. One of the attackers should always be free to take a pass.
4. If defenders choose to mark two attackers, then the one receiving the ball must take a shot.
5. Players may tend to want to dribble or pass the ball almost into the goal. Remind them that they are within shooting distance as soon as they receive the first pass.
6. Defenders need to follow the principle of one defender challenging player with ball, the second defender covering behind the first defender, goal side with opportunity to intercept passes.
7. Set up the teams according to your system of play, or to try out some players in different positions.

Variation: depending on success, add or take away a defender.

Game Application

Scoring plays develop either down the flanks with crosses or through passing combinations through the middle. Spaces and players are marked tightly at the top of the penalty box. This drill gets your players used to each other in tight marking situations. they need to learn each others runs, passing preferences, reaction speeds, shooting foot preferences, etc.

This is a very effective drill isolating a critical element of attacking soccer.

Advanced teams must demand that their attacking players take their shots the moment the opportunity presents itself. Slight delays or additional touches must be removed from their game.

FAST BREAK SOCCER PRACTICE # 19

Warm Up (20 min)

A. Out-In Passing

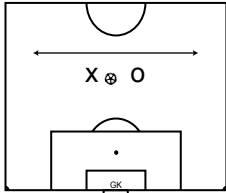

X and O start 2m apart. They one touch pass to each other taking a few steps backwards after each pass to increase passing distance. Once they get to sideline, they decrease distance back to the middle of field.

B. Runner's & hamstring stretches

C. "3v2 On 5 Goals"

X's each have a ball and must dribble through small (2m wide) goals. O's try to win ball and if they do, they now try to dribble through goals while X who lost ball defends. Players cannot dribble through same goal twice in a row.

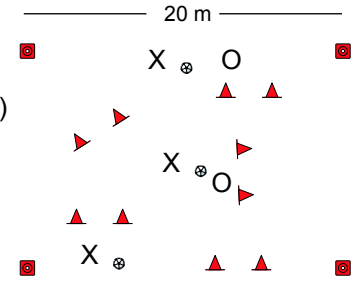

D. Quad and personal stretches

Transition Play (30 min)

Attackers (A) play on regular goal.

Defenders (D) try to gain possession and if successful, counter attack through two small goals positioned at the half line.

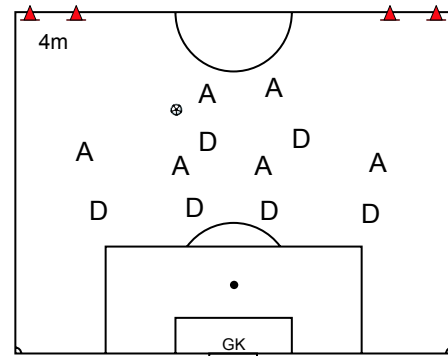

Soccer Speed (10 min)

- M starts with ball and plays to either X1 or X2
 - D defends two small (2m) goals and reacts to pass by M.
 - D tries to block shot by X2.
- X's and M pass back and forth to get clear shot. Rotate players every 2 min.

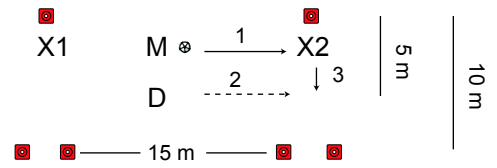

Goal Scoring (20 min)

4 groups of three (add a 5th if needed) are numbered 1 through 4.

Players one-touch pass the ball amongst each other.

Coach calls out the number of a group (1-4). As soon as the call is made, the player that made the last pass and the player with the ball play 2v1 on goal against the third player.

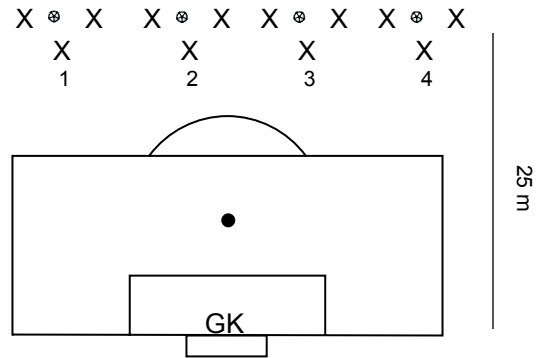

Game Tactics (30 min)

8v8 on full field.

Team in possession must pass to a team mate running into one of four grids in the corners of the field.

After a successful pass, the other team gets the ball and must play across center field first before they can pass into a grid.

Each successful pass into a grid scores one point.

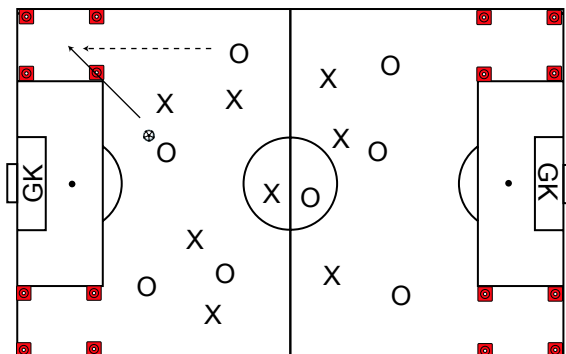

Players should be busy at all times. If drills keep players inactive, break team into smaller groups and run parallel drills.

FAST BREAK SOCCER WARM UP # 19

Out-In Passing & 3 v 2 On 5 Goals

A. Out-In Passing

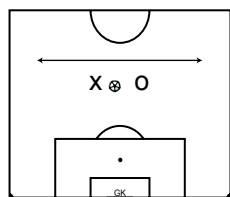

X and O start 2m apart. They one touch pass to each other taking a few steps backwards after each pass to increase passing distance. Once they get to sideline, they decrease distance back to the middle of field.

C. 3v2 On 5 Goals

X's each have a ball and must dribble through small (2m wide) goals. O's try to win ball and if they do, they now try to dribble through goals while X who lost ball defends. Players cannot dribble through same goal twice in a row.

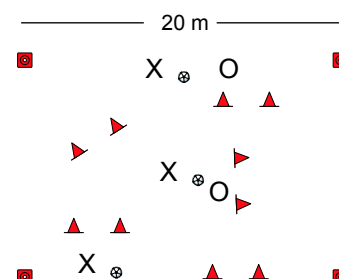

B. Runner's & Hamstring Stretches

D. Quad and Personal Stretches

Coaching Points

Out - In Passing:

1. Players must stay in straight line, i.e. passes must be accurate and straight. Otherwise groups will collide and balls will bounce all over the field. This requires accurate passing and peripheral vision to be aware of where groups are relative to each other. Should a pair go "off-course", ask them to work ball back to their spot.
2. Passes must be on ground, properly weighted for easy control. If a pass is off-line, too hard or too high, allow players one touch to control ball before passing it back.

3v2 On 5 Goals:

1. Attacking players need to keep head up to be aware of which goal is open for them. They must avoid going for the same goal as someone else. This will also make it easier to defend.
2. Quick fakes and changes of direction to beat a defender are encouraged.
3. Defenders need to communicate and work as a team. They cannot stop all three attackers at the same time but they could both challenge one attacker. They can also tell each other which attacker may be easiest to challenge.

Game Application

The technical aspects of these drills is peripheral vision and awareness of players and field around.

This is important in games to utilize open spaces for dribbling or to see runs by team mates into spaces that then can be passed to. Also, awareness of movements of the opponents helps in maintaining possession.

One touch passing accelerates the pace of play. Needing to pass while running backwards is not a typical game situation, however, it does train balance, agility and ball control.

Change of direction dribbles are a fundamental soccer skill and awareness of opportunity and available space is vital.

FAST BREAK SOCCER TRANSITION PLAY # 19

6 v 6 with Counterattack

Attackers (A) play on regular goal.

Defenders (D) try to gain possession and if successful, counter attack through two small goals positioned at the half line.

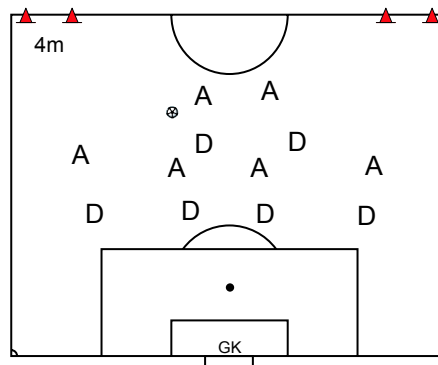

Coaching Points

1. Teams must play as they would a regular game. They need to use width of field, mix up flank attacks with central attacks, switch play, etc. Stress two touch soccer to speed up transition.
2. This is a great drill to test/train various systems of play and various game situations.

The example shown shows a 4-4-2 vs 4-4-2 and would be played with 4 midfielders and 2 strikers against 4 defenders and 2 midfielders. It could also be adjusted to play with 2 defenders/2 midfielders/2 strikers against 4 defenders/2 strikers.

If you played a 3-5-2 you could play 3 defenders/3 midfielders against 4 midfielders/2 strikers to train your defense to play against a 4-4-2.

3. Defenders counterattacking can play a long ball through small goals or work the ball up the field with 2-4 quick one or two touch passes. Discourage one defender taking the ball and dribbling the length of the field trying to get through goal.
4. Rotate extra players into positions.
5. Defending team may not transition everyone out of their third. Do not allow them to be content with defending only.

Game Application

The most effective counterattacks play the ball wide first to open space. This prevents the opponensts to possibly regain the ball if played through the middle which would put them in a good scoring position.

This does not mean counterattacks always go wide. If there is space in the middle of the field, play it out through the middle and then use wide or central spaces.

This drill essentially provides frequent opportunities to practice attacking plays and counterattack by playing on half the field.

This trains essential communication amongst defenders to ensure all attackers are properly marked.

FAST BREAK SOCCER SPEED # 19

Defend 2 Goals

1. M starts with ball and plays to either X1 or X2
 2. D defends two small (2m) goals and reacts to pass by M.
 3. D tries to block shot by X2.
- X's and M pass back and forth to get clear shot.

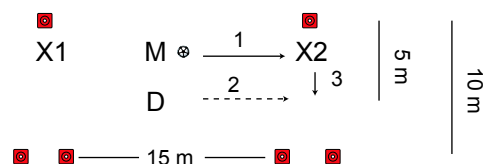

Rotate players every 2 min.

Coaching Points

1. X's must always play ball through M, they cannot pass directly to each other.
2. X's and M must move the ball faster than D can react and sprint between goals so that they have a clear shot on goal.
3. X with ball can fake a pass to M to see if D reacts and then shoot on goal.
4. D needs to react to passes to block shots.

Game Application

Reaction speed to the opponent's plays will improve your chances of gaining possession and starting a fast break attack. At the same time, when your team has the ball, they need to be able to recognize blocked spaces and passing lanes and combine for a quick change of direction.

This particular drill is excellent for training the agility, ball control, quick turns and decision making of player M in the middle.

All players in this drill are training decision making speed, movement speed, and reaction speed, all vital elements of modern soccer and in particular FAST BREAK SOCCER.

FAST BREAK SOCCER GOAL SCORING # 19

Passing & Reaction 2 v 1 On Goal

4 groups of three (add a 5th if needed) are numbered 1 through 4.

Players one-touch pass the ball amongst each other.

Coach calls out the number of a group (1-4).

As soon as the call is made, the player that made the last pass and the player with the ball play 2v1 on goal against the third player.

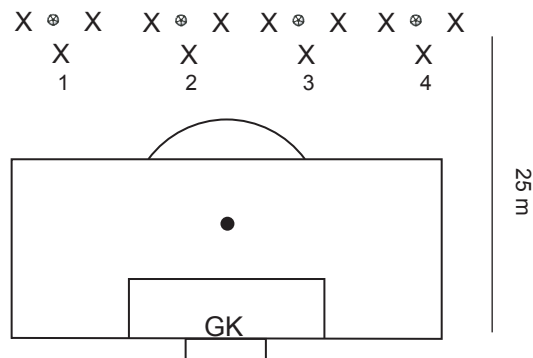

Coaching Points

1. After the call, the 2v1 must go direct and quick on goal. Do not allow extensive 1v1 dribbling or extensive back and forth passing.
2. This drill is close to goal, so players should take the earliest opportunity to shoot. They don't need to play 2v1 if at the call the player with the ball has a clear shot.
3. Allow no more than 5 seconds for a group to generate a shot on goal. If they take longer, stop play and ask them to clear out.
4. After a group is done, they must leave field quickly to allow next group to play. As soon as a group is out of the way, call the next number.
5. The group coming off takes the spot of the group that is now playing.
6. If groups don't get back fast enough and you have less than 3 groups passing, stop and reset drill.

Game Application

Plays at the top of the penalty box must generate shots on goal quickly. As soon as there is a gap for the ball to go through the defense, a shot must be taken.

This drill trains reaction and perception speed since players engaged in passing plays must perceive an audible signal and immediately change their actions. This must happen in games where your players communicate instructions to each other.

The player who turns defender is training reaction speed and transition from being a potential attacker to now being a defender. That player needs to decide whether to challenge the ball carrier or whether to make an angled recovery run to cut off a shooting angle.

FAST BREAK SOCCER GAME TACTICS # 19

8 v 8 Into 4 Corners

8v8 on full field.

Team in possession must pass to a team mate running into one of four grids in the corners of the field.

After a successful pass, the other team gets the ball and must play across center field first before they can pass into a grid.

Each successful pass into a grid scores one point.

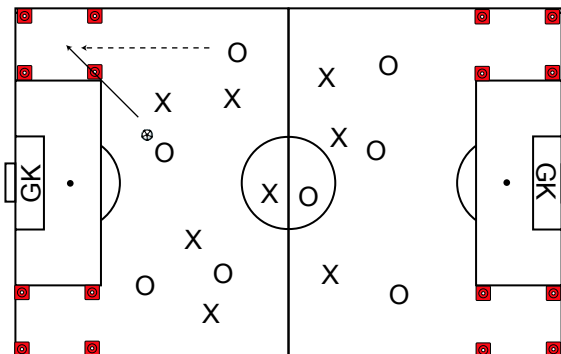

Coaching Points

1. Players will have a tendency to run into square and wait for a pass. They can only run into square to receive a pass already played.
2. Teams will tend to attack one square and stay in that corner trying to pass the ball into that square. If that happens stop the play and point out the wide open spaces and the three other open squares. Encourage teams to switch play. They have three great opportunities to change the point of attack:
 - a. they can play across to the square in the same half
 - b. they can play "vertical" down the line to the square on same side of field in other half
 - c. they can play diagonally across to other half.
3. Encourage communication amongst team in possession to switch play if space is available.
4. Encourage players to make runs into space with a loud shout to team mates that they are available.

Game Application

This drill is designed to train one of the two main attacking plays - flank attack.

Switching points of attack opens up spaces and opportunities for a faster approach to the opponent's goal.

Teams gaining possession in their own half (in this drill after the other team played into square) must break out quickly across half to catch opponents off-balance and out of position. This increases probability of generating good scoring chances and scoring more goals.

FAST BREAK SOCCER PRACTICE # 20

Warm Up (20 min)

A. Head Or Catch

X throws ball high to O and calls out "head" or "catch". If "head", O heads ball back to X, if "catch" O catches ball and throws back to X.

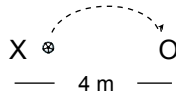

Change roles every 60 seconds.

C. Reverse Head Or Catch

Same as A, except O now has to do the opposite of what X calls.

X calls "head" - O catches.

X calls "catch" - O heads.

B. Runner's & hamstring stretches

D. Quad and personal stretches

Transition Play (30 min)

Divide team into three equal groups.

A and C play ball through B to each other.

If one of the end groups (A/C) plays ball out of bounds, then that group goes in middle and middle group takes their place.

If middle group intercept, they change place with group who last had possession

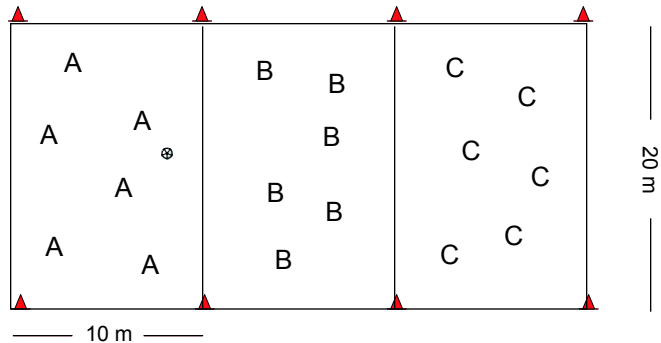

Soccer Speed (10 min)

X and O face goal. X is designated as the lead. X and O jog backwards away from ball. X decides to sprint forward to ball and is now the attacker. O reacts and becomes defender in a 1v1.

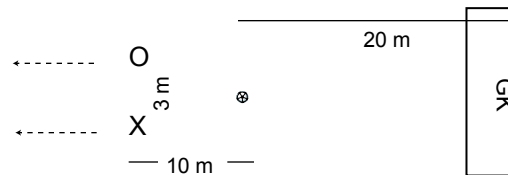

Goal Scoring (20 min)

1. A passes ball to defender D.
2. D one touch passes back to A.
3. A now plays 1v1 against D. D can only move laterally between cones.
4. After A gets past D,
5. A takes a shot on goal.
6. A then converts a cross from server S on far side in quick succession.

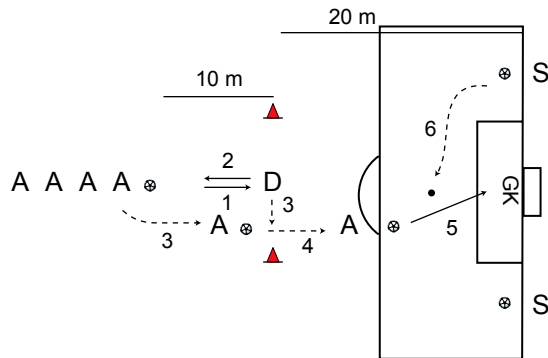

Game Tactics (30 min)

Teams play 4v4.

Each team can score in either goal.

After a goal is scored, play restarts with goalkeeper throwing ball across half to the team that was scored on.

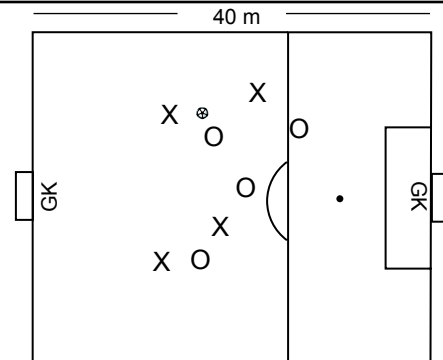

Players should be busy at all times. If drills keep players inactive, break team into smaller groups and run parallel drills.

FAST BREAK SOCCER WARM UP # 20

Head or Catch

A. Head Or Catch

X throws ball high to O and calls out "head" or "catch".

If "head", O heads ball back to X,
if "catch" O catches ball and throws back to X.

Change roles every 60 seconds.

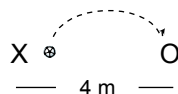

C. Reverse Head Or Catch

Same as A, except O now has to do the opposite of what X calls.

X calls "head" - O catches.

X calls "catch" - O heads.

B. Runner's & Hamstring Stretches

D. Quad and Personal Stretches

Coaching Points

1. Throws must be accurate and arched properly to allow for a header.
2. Players throwing must make the call as the ball leaves their hand.
3. Ideally, headers should be "jumping headers".

Game Application

The purpose of this drill is to train reaction speed and reflex.

Particularly in the penalty box, balls can deflect from shots or headers and players need to be able to react to it. Sometimes the ball deflects in a direction different than anticipated by a player and the player has to make an instant adjustment. This is trained by the second part of this drill.

FAST BREAK SOCCER TRANSITION PLAY # 20

Passing Through Traffic

Divide team into three equal groups.

A and C play ball through B to each other.

If one of the end groups (A/C) plays ball out of bounds, then that group goes in middle and middle group takes their place.

If middle group intercept, they change place with group who last had possession

The team that stays in its position restarts play.

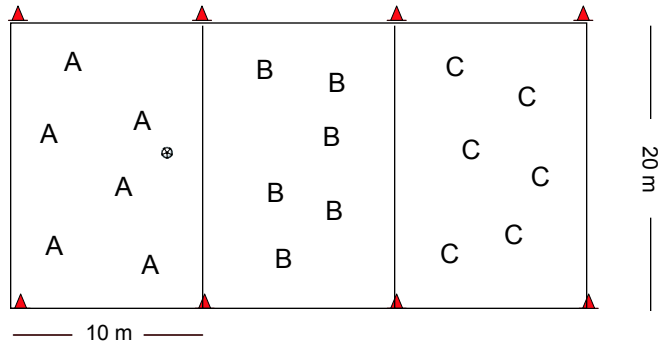

Coaching Points

1. Team in possession must be in constant motion to play ball into a position that allows a pass through center group. The danger is that players are static and just try to drive ball through traffic.
2. Give teams a point for each completed pass and count points per team every 5 minutes.
3. This is a transition drill. Therefore if there is an out of bounds ball or an interception, the middle team and the team that lost possession must exchange places as fast as possible. Encourage them to sprint.
4. If skill permits, limit play to two touches.
5. Limit total number of touches by a team before playing the pass to encourage fast play.

Game Application

Passing balls through tight spaces is an important skill in modern soccer where play takes place in ever more compacting areas.

Transitioning quickly from defense to offence and vice versa is THE key to Fast Break Soccer.

Players must develop the habit and fitness to sprint into their new positions and roles during transition.

The ability to see and execute a penetrating pass through opponents to team mates further up the field is extremely important in fast break soccer.

FAST BREAK SOCCER SPEED # 20

Backward Jog - Sprint -1 v 1

X and O face goal. X is designated as the lead.

X and O jog backwards away from ball.

X decides to sprint forward to ball and is now the attacker.

O reacts and becomes defender in a 1v1.

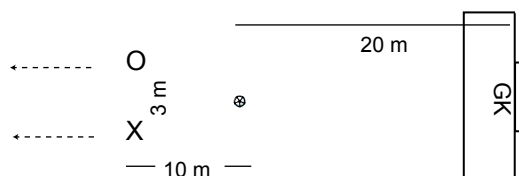

Coaching Points

1. Restrict the backwards jog to about 5 m.
2. It is ok for the lead player trying to fake out the other player with fake forward starts. However, they must keep the drill moving quickly. Speed the players up if they get too fancy.
3. The forward sprint must be all out.
4. The defending player must make a recovery run to get between the attacker and the goal.
5. Defenders putting pressure on 50% of shots in this drill are doing well, blocking a shot will be exceptional.
6. Attackers should target to finish 75% of their attacks with a shot.
7. Goalkeepers must be ready to come out and save any bad first touches from attackers.
8. Ask attackers to shoot with first or second touch.

Game Application

Players get in a position where they must jog backwards, retreating defenders in particular.

If the direction of play changes by the defending team winning the ball, retreating defenders now must sprint forward to help with the quick transition to a fast break counterattack.

A defender who has been passed must get back into the play by making a "recovery" run, which is goal side of the player with the ball - quite a common game situation.

FAST BREAK SOCCER GOAL SCORING # 20

Wall Pass - 1 v 1 - Shot - Cross - Finish

1. A passes ball to defender D.
2. D one touch passes back to A .
3. A now plays 1v1 against D. D can only move laterally between cones.
4. After A gets past D,
5. A takes a shot on goal.
6. A then converts a cross from server S on far side in quick succession.

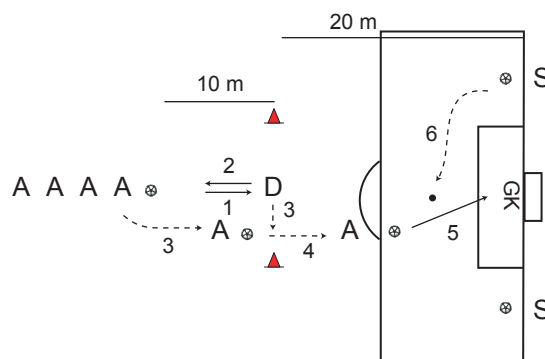

Coaching Points

1. The initial pass between A and D must be on the ground and properly weighted to allow easy ball control. If D has difficulty returning a one touch pass properly - allow a two touch pass.
2. Defenders will naturally tend to come out and challenge the attacker. Emphasize that this is a goal scoring drill and ask them to stay between cones.
3. The attacker should approach defender from a central position and then use body fakes and 1v1 moves to beat the defender.
4. The servers need to communicate as to who will serve the cross, particularly if it isn't clear from which side the shot was taken (i.e. from penalty spot).
5. Servers should kick the ball low or for headers. If they are inaccurate and cannot play a precise cross, ask someone else or allow them to throw the ball for the cross.
6. Servers can be wide midfielders or defenders, players who ordinarily cross during a game.
7. Rotate defenders through position D.
8. Attackers should aim for 75% success (scoring)

Game Application

Wall passes are common and typically happen between midfielder and a striker with their back to goal, or between two strikers.

1v1 at the top of the penalty box are excellent opportunities to set up a shot from a preferred position.

Reacting to the cross after the shot simulates reacting to a rebound in a crowded penalty box.

Fast break soccer creates many scoring chances, but they must be converted at a high rate to ensure your team WINS.

FAST BREAK SOCCER GAME TACTICS # 20

4 v 4 On Either Goal

Teams play 4v4.

Each team can score in either goal.

After a goal is scored, play restarts with goalkeeper throwing ball across half to the team that was scored on.

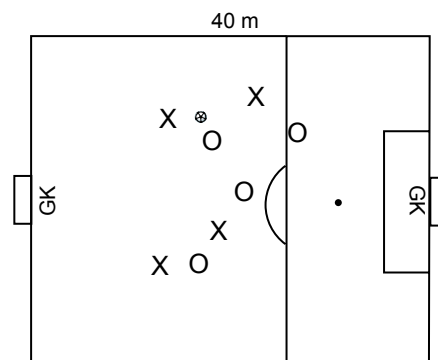

Coaching Points

1. Teams may focus too much on passing close to net for a shot and not realize that they are playing on a short narrow field. Players will often be within shooting distance after they receive a pass.
2. The team in possession may get bogged down in a 4v4 attacking one goal. Remind them that they can (should) change direction and break towards the opposite goal. This typically requires one player to recognize the space, take the initiative to make the run in the opposite direction and very loudly ask for the break out pass.
3. If a team wins possession close to goal, they must react and take a quick shot. This is a key mental transition requirement and goes against what a defender ordinarily does.

Game Application

The key game application is to realize when players are within scoring distance and then take a shot.

Another important aspect is to recognize space and take the initiative to shift play into that available space. This requires decision making and fast game speed.

As has been the theme of FAST BREAK SOCCER, this drill combines all elements of attacking soccer:

Generating many chances, taking lots of shots, shifting play quickly into available spaces, reacting quickly to change of possession, and mentally and physically transitioning quickly from defense to offense and offense to defense.